

Features

- Peak power dissipation 6600W @10 x 1000 us Pulse
- Glass passivated junction.
- Excellent clamping capability.
- High surge capability
- Low leakage current
- Low forward voltage drop
- Available in uni-directional polarity only
- $T_J = 175^\circ\text{C}$ capability suitable for high reliability and automotive requirement
- Meets ISO7637-2 surge specification (varied by test condition)
- AEC-S101 qualified
- Plastic Case Material has UL Flammability Classification Rating 94V-O

DO-218AB/SMD-BLOCK

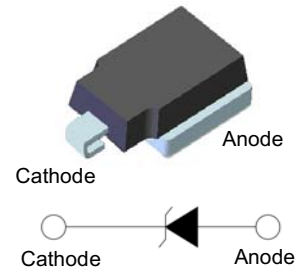

Mechanical Data

- Case: Void-free, DO-218AB/SMD-BLOCK Transfer Molded Plastic
- Polarity: Cathode Band or Cathode Notch
- Marking:
Unidirectional – Device Code and Cathode Band
Bidirectional – Device Code Only
- **Lead Free: For Halogen free and RoHS / Lead Free Version**

Maximum Ratings and Electrical Characteristics @ $T_A=25^\circ\text{C}$ unless otherwise specified

MAXIMUM RATINGS ($T_C = 25^\circ\text{C}$ unless otherwise noted)				
PARAMETER		SYMBOL	VALUE	UNIT
Peak pulse power dissipation	with 10/1000 μs waveform with 10/10 000 μs waveform	P_{PPM}	6600 5200	W
Power dissipation on infinite heatsink at $T_C = 25^\circ\text{C}$ (Fig. 1)		P_D	8.0	W
Peak pulse current with 10/1000 μs waveform ⁽¹⁾		I_{PPM}	see next table	A
Peak forward surge current 8.3 ms single half sine-wave		I_{FSM}	700	A
Operating junction and storage temperature range		T_J, T_{STG}	- 55 to + 175	$^\circ\text{C}$

Note:

(1) Non-repetitive current pulse derated above $T_A = 25^\circ\text{C}$

THERMAL CHARACTERISTICS ($T_C = 25^\circ\text{C}$ unless otherwise noted)				
PARAMETER		SYMBOL	VALUE	UNIT
Typical thermal resistance, junction to case		$R_{\theta JC}$	0.90	$^\circ\text{C/W}$

I-V Curve Characteristics

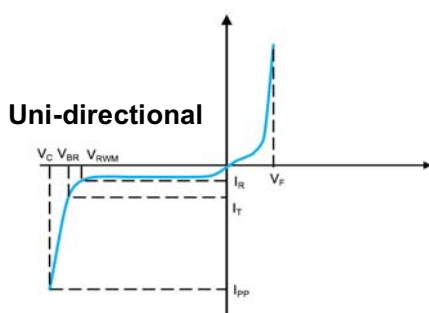

RATINGS AND CHARACTERISTICS CURVES

($T_A = 25\text{ }^\circ\text{C}$ unless otherwise noted)

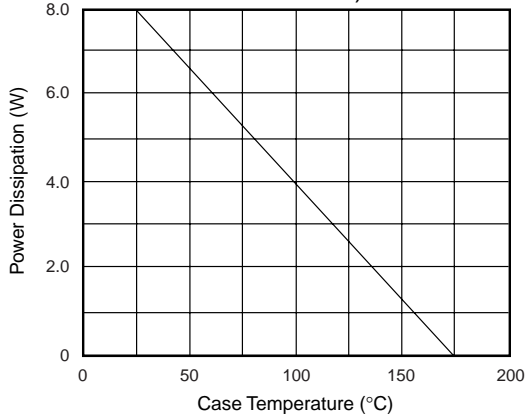

Figure 1. Power Derating Curve

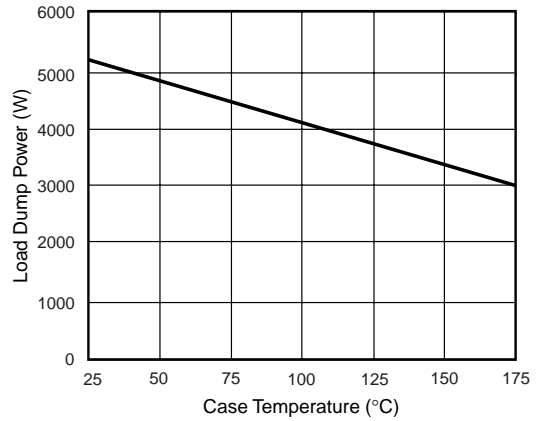

Figure 2. Load Dump Power Characteristics (10 ms Exponential Waveform)

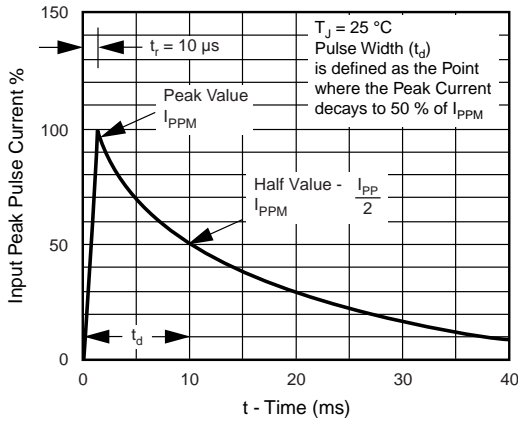

Figure 3. Pulse Waveform

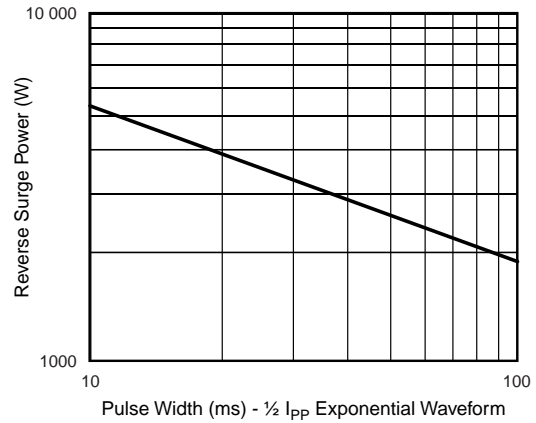

Figure 4. Reverse Power Capability

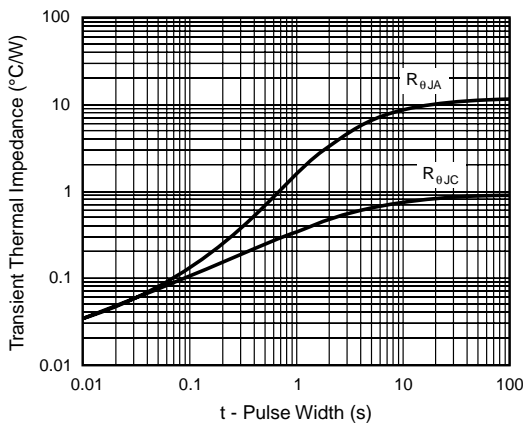

Figure 5. Typical Transient Thermal Impedance

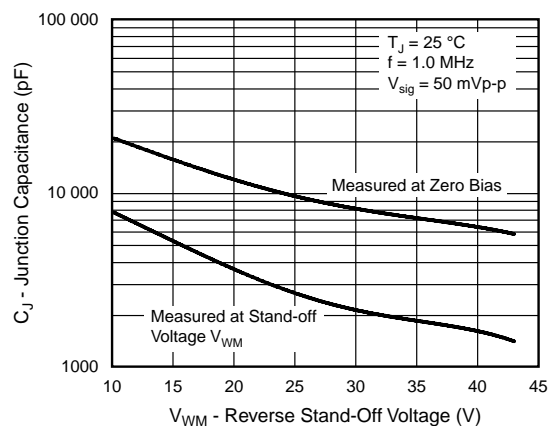

Figure 6. Typical Junction Capacitance

- P_{PPM}** Peak Pulse Power Dissipation - Max power dissipation
- V_{RWM}** Reverse Stand-off Voltage - Maximum voltage that can be applied to TVS without operation
- V_{BR}** Breakdown Voltage – Maximum voltage that flows though the TVS at a specified current (I_T)
- V_C** Clamping Voltage – Peak voltage measured across the TVS at a specified I_{PPM} (peak impulse current)
- I_R** Reverse Leakage Current – Current measured at V_R
- V_F** Forward Voltage Drop for Uni-directional

ELECTRICAL CHARACTERISTICS (T_C = 25 °C unless otherwise noted)

Type Number	Reverse Stand-Off Voltage	Breakdown Voltage Min. @I _T	Breakdown Voltage Max. @ I _T	Test Current	Maximum Clamping Voltage @I _{PP}	Peak Pulse Current	Reverse Leakage @V _{RMW}
(uni)	V _{RMW} (V)	V _{BR MIN} (V)	V _{BR MAX} (V)	I _T (mA)	V _C (V)	I _{PP} (A)	I _R (uA)
SM8S10	10	11.1	14.1	5.0	18.8	351	15.0
SM8S10A	10	11.1	12.8	5.0	17.0	388	15.0
SM8S11	11	12.2	15.4	5.0	20.1	328	10.0
SM8S11A	11	12.2	14.0	5.0	18.2	363	10.0
SM8S12	12	13.3	16.9	5.0	22.0	300	10.0
SM8S12A	12	13.3	15.3	5.0	19.9	332	10.0
SM8S13	13	14.4	18.2	5.0	23.8	277	10.0
SM8S13A	13	14.4	16.5	5.0	21.5	307	10.0
SM8S14	14	15.6	19.8	5.0	25.8	256	10.0
SM8S14A	14	15.6	17.9	5.0	23.2	284	10.0
SM8S15	15	16.7	21.1	5.0	26.9	245	10.0
SM8S15A	15	16.7	19.2	5.0	24.4	270	10.0
SM8S16	16	17.8	22.6	5.0	28.8	229	10.0
SM8S16A	16	17.8	20.5	5.0	26.0	254	10.0
SM8S17	17	18.9	23.9	5.0	30.5	216	10.0
SM8S17A	17	18.9	21.7	5.0	27.6	239	10.0
SM8S18	18	20.0	25.3	5.0	32.2	205	10.0
SM8S18A	18	20.0	23.3	5.0	29.2	226	10.0
SM8S20	20	22.2	28.1	5.0	35.8	184	10.0
SM8S20A	20	22.2	25.5	5.0	32.4	204	10.0
SM8S22	22	24.4	30.9	5.0	39.4	168	10.0
SM8S22A	22	24.4	28.0	5.0	35.5	186	10.0
SM8S24	24	26.7	33.8	5.0	43.0	153	10.0
SM8S24A	24	26.7	30.7	5.0	38.9	170	10.0
SM8S26	26	28.9	36.6	5.0	46.6	142	10.0
SM8S26A	26	28.9	33.2	5.0	42.1	157	10.0
SM8S28	28	31.1	39.4	5.0	50.0	132	10.0
SM8S28A	28	31.1	35.8	5.0	45.4	145	10.0
SM8S30	30	33.3	42.2	5.0	53.5	123	10.0
SM8S30A	30	33.3	38.3	5.0	48.4	136	10.0
SM8S33	33	36.7	46.5	5.0	59.0	112	10.0
SM8S33A	33	36.7	42.2	5.0	53.3	124	10.0
SM8S36	36	40.0	50.7	5.0	64.3	103	10.0
SM8S36A	36	40.0	46.0	5.0	58.1	114	10.0
SM8S40	40	44.4	56.3	5.0	71.4	92.4	10.0
SM8S40A	40	44.4	51.1	5.0	64.5	102	10.0

Package Outline Dimensions and Pad Layouts

DO-218AB/SMD-BLOCK (mm)

