

Features

- Ideally Suited for Automatic Assembly
- Low Forward Voltage Drop, High Efficiency
- Surge Overload Rating to 100A Peak
- Low Power Loss
- Ultra-Fast Recovery Time
- Plastic Case Material has UL Flammability Classification Rating 94V-O

Mechanical Data

- Case: SMC/DO-214AB, Molded Plastic
- Terminals: Solder Plated, Solderable per MIL-STD-750, Method 2026
- Polarity: Cathode Band or Cathode Notch
- Marking: Type Number
- Weight: SMB Weight: 0.093 grams (approx.)
SMC Weight: 0.20 grams (approx.)
- **Lead Free: For RoHS / Lead Free Version**

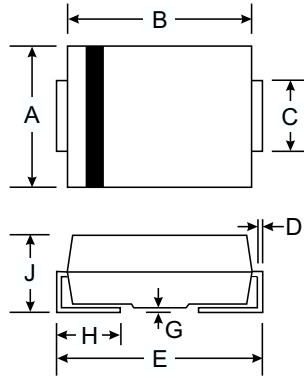

Dim	SMB		SMC	
	Min	Max	Min	Max
A	3.30	3.94	5.59	6.22
B	4.06	4.57	6.60	7.11
C	1.96	2.21	2.75	3.18
D	0.15	0.31	0.15	0.31
E	5.00	5.59	7.75	8.13
G	0.10	0.20	0.10	0.20
H	0.76	1.52	0.76	1.52
J	2.00	2.62	2.00	2.62

All Dimensions in mm

Maximum Ratings and Electrical Characteristics @ $T_A=25^\circ\text{C}$ unless otherwise specified

Characteristic	Symbol	RS3A	RS3B	RS3D	RS3G	RS3J	RS3K	RS3M	Unit
Peak Repetitive Reverse Voltage	V_{RRM}	50	100	200	400	600	800	1000	V
Working Peak Reverse Voltage	V_{RWM}								
DC Blocking Voltage	V_R								
RMS Reverse Voltage	$V_{R(RMS)}$	35	70	140	280	420	560	700	V
Average Rectified Output Current @ $T_L = 100^\circ\text{C}$	I_O	3.0							A
Non-Repetitive Peak Forward Surge Current 8.3ms Single half sine-wave superimposed on rated load (JEDEC Method)	I_{FSM}	100							A
Forward Voltage @ $I_F = 3.0\text{A}$	V_{FM}	1.28							V
Peak Reverse Current @ $T_A = 25^\circ\text{C}$ At Rated DC Blocking Voltage @ $T_A = 100^\circ\text{C}$	I_{RM}	2.0 500							μA
Reverse Recovery Time (Note 1)	t_{rr}	150				250	450		nS
Typical Junction Capacitance (Note 2)	C_j	50							pF
Typical Thermal Resistance (Note 3)	$R_{\theta JL}$	30							$^\circ\text{C/W}$
Operating and Storage Temperature Range	T_j, T_{STG}	-55 to +150							$^\circ\text{C}$

Note: 1. Measured with $I_F = 0.5\text{A}$, $I_R = 1.0\text{A}$, $I_{rr} = 0.25\text{A}$. See figure 5.
2. Measured at 1.0 MHz and applied reverse voltage of 4.0 V DC.
3. Mounted on P.C. Board with 8.0mm² land area.

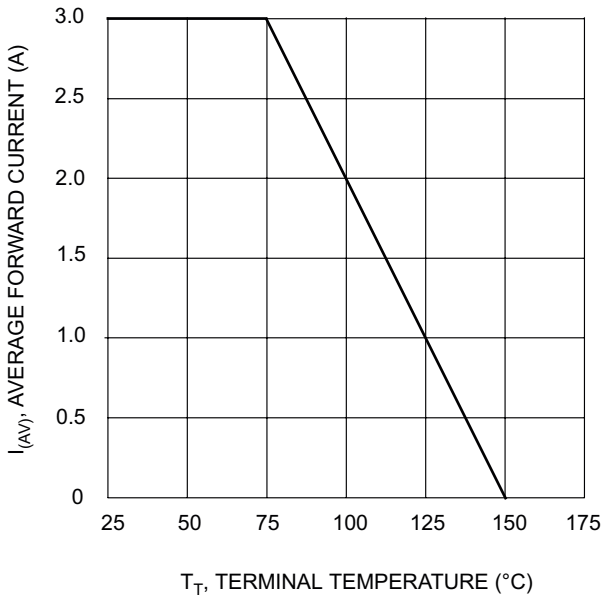

T_T , TERMINAL TEMPERATURE (°C)
Fig. 1 Forward Current Derating Curve

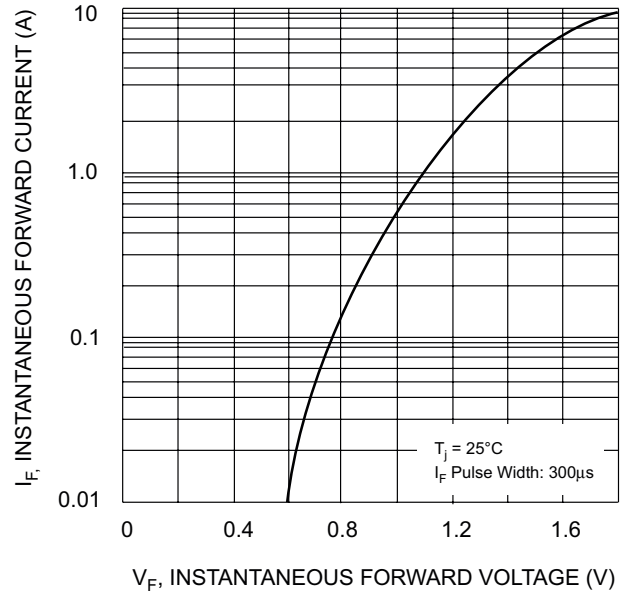

V_F , INSTANTANEOUS FORWARD VOLTAGE (V)
Fig. 2 Typical Forward Characteristics

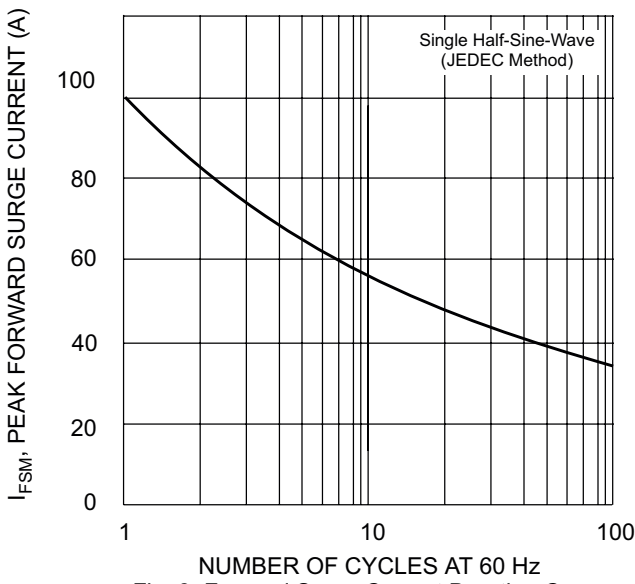

Fig. 3 Forward Surge Current Derating Curve

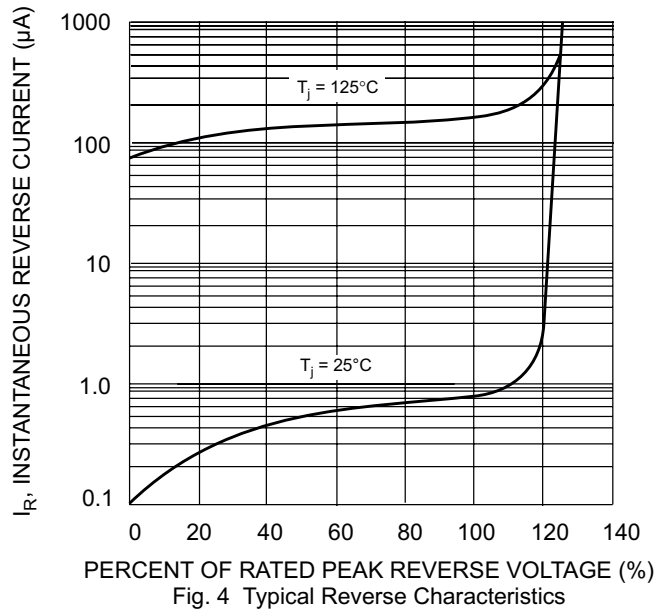
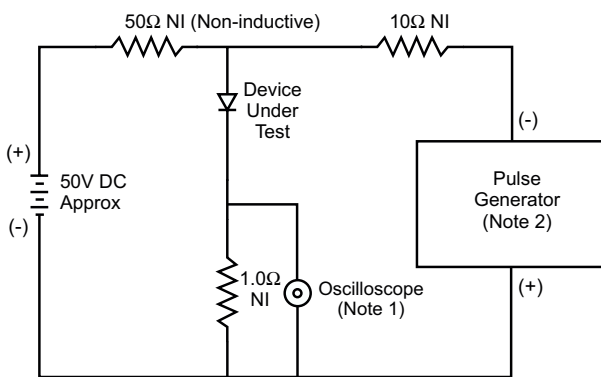
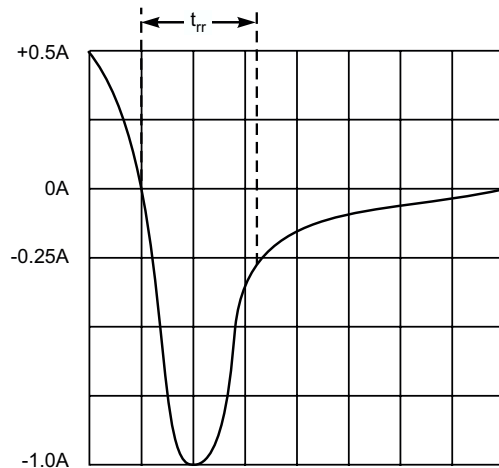

Fig. 4 Typical Reverse Characteristics



- Notes:
1. Rise Time = 7.0ns max. Input Impedance = 1.0MΩ, 22pF.
 2. Rise Time = 10ns max. Input Impedance = 50Ω.



Set time base for 50/100 ns/cm

Fig. 5 Reverse Recovery Time Characteristic and Test Circuit