

0.8A FAST RECOVERY SURFACE MOUNT GLASS PASSIVATED BRIDGE RECTIFIER

Features

- Glass Passivated Die Construction
- Low Forward Voltage Drop
- High Current Capability
- High Surge Current Capability
- Designed for Surface Mount Application
- Plastic Material – UL Flammability 94V-O

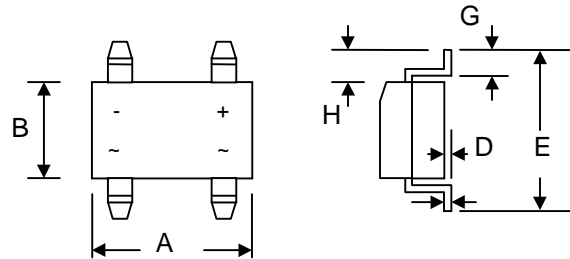

Mechanical Data

- Case: MB-F, Molded Plastic
- Terminals: Plated Leads Solderable per MIL-STD-202, Method 208
- Polarity: As Marked on Case
- Weight: 0.134 grams (approx.)
- Mounting Position: Any
- Marking: Type Number
- **Lead Free: For RoHS / Lead Free Version**

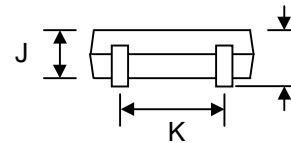

MB-F		
Dim	Min	Max
A	4.50	4.95
B	3.60	4.10
C	0.15	0.35
D	—	0.20
E	6.40	7.00
G	0.50	1.10
H	1.30	1.70
J	1.20	1.60
K	2.30	2.70
L	—	1.80
All Dimensions in mm		

Maximum Ratings and Electrical Characteristics @T_A=25°C unless otherwise specified

Single Phase, half wave, 60Hz, resistive or inductive load.
For capacitive load, derate current by 20%.

Characteristic	Symbol	RMB 05F	RMB 1F	RMB 2F	RMB 4F	RMB 6F	RMB 8F	RMB 10F	Unit	
Peak Repetitive Reverse Voltage	V _{RRM}	50	100	200	400	600	800	1000	V	
Working Peak Reverse Voltage	V _{RWM}									
DC Blocking Voltage	V _R									
RMS Reverse Voltage	V _{R(RMS)}	35	70	140	280	420	560	700	V	
Average Rectified Output Current (Note 1) @T _A = 40°C	I _O	0.5							A	
Average Rectified Output Current (Note 2) @T _A = 40°C		0.8								
Non-Repetitive Peak Forward Surge Current 8.3ms Single half sine-wave superimposed on rated load (JEDEC Method)	I _{FSM}	30							A	
I ² t Rating for Fusing (t < 8.3ms)	I ² t	5.0							A ² s	
Forward Voltage per element @I _F = 0.8A	V _{FM}	1.3							V	
Peak Reverse Current @T _A = 25°C At Rated DC Blocking Voltage @T _A = 125°C	I _{RM}	5.0 500							μA	
Reverse Recovery Time (Note 4)	t _{rr}	150					250	500		nS
Typical Junction Capacitance per leg (Note 3)	C _j	13							pF	
Typical Thermal Resistance per leg (Note 1)	R _{θJA} R _{θJL}	62.5 25							°C/W	
Operating and Storage Temperature Range	T _j , T _{STG}	-55 to +150							°C	

Note: 1. Mounted on glass epoxy PC board with 1.3mm² solder pad.
2. Mounted on aluminum substrate PC board with 1.3mm² solder pad.
3. Measured at 1.0 MHz and applied reverse voltage of 4.0V D.C.
4. Measured with I_F = 0.5A, I_R = 1.0A, I_{RR} = 0.25A. See figure 5.

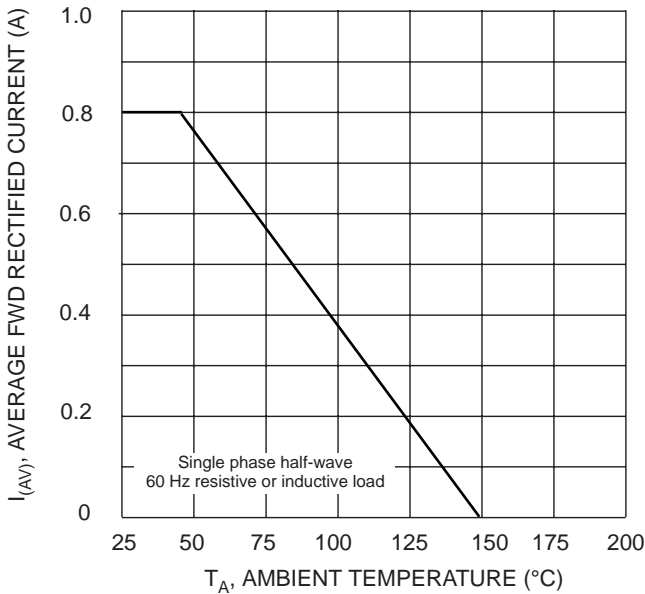

Fig. 1 Forward Derating Curve

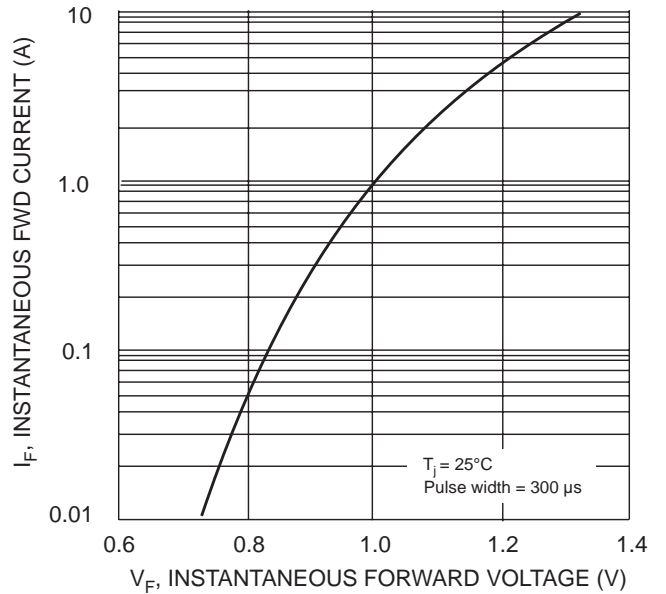

Fig. 2 Typical Forward Characteristics

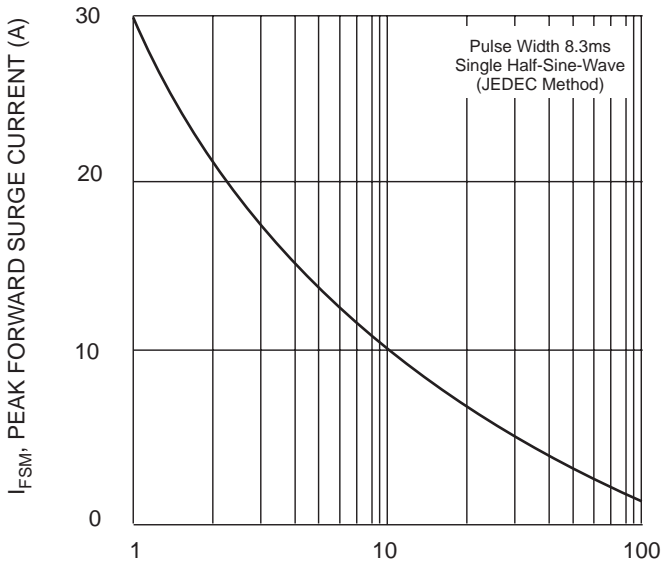

Fig. 3 Peak Forward Surge Current

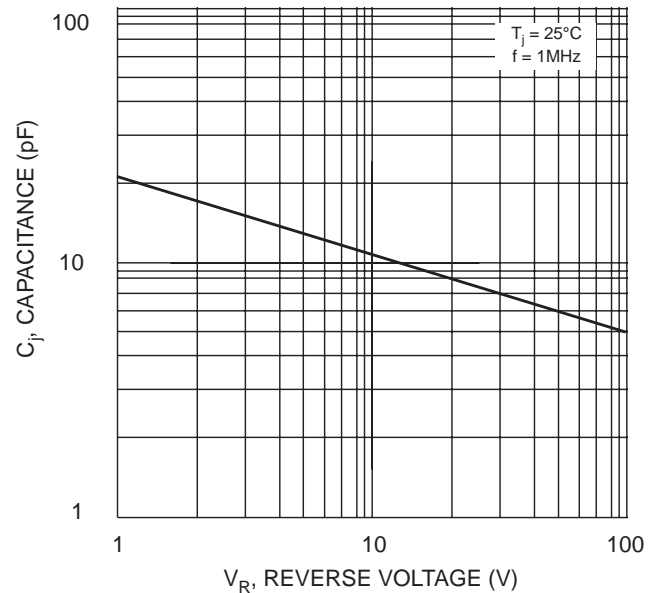
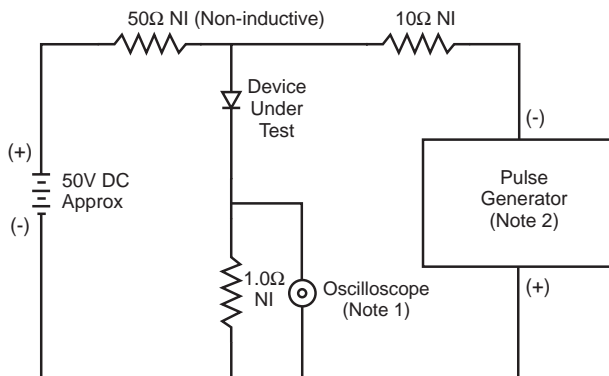
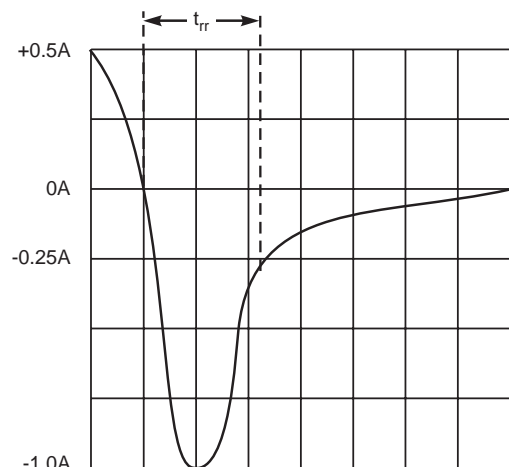

Fig. 4 Typical Junction Capacitance



- Notes:
1. Rise Time = 7.0ns max. Input Impedance = 1.0MΩ, 22pF.
 2. Rise Time = 10ns max. Input Impedance = 50Ω.



Set time base for 5/10ns/cm

5 Reverse Recovery Time Characteristic and Test Circuit