

Features

- Glass Passivated Die Construction
- Low Forward Voltage Drop
- High Current Capability
- High Surge Current Capability
- Designed for Surface Mount Application
- Plastic Material – UL Flammability 94V-0

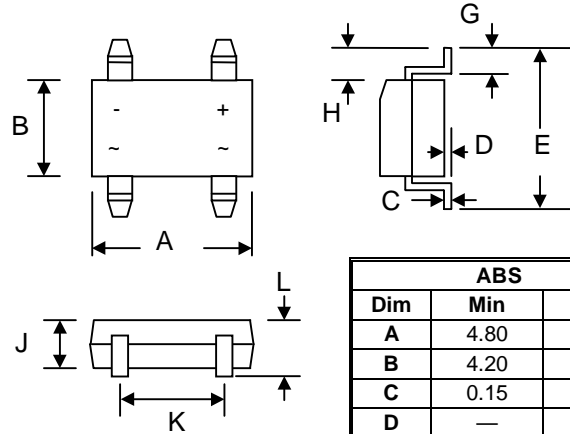

ABS		
Dim	Min	Max
A	4.80	5.30
B	4.20	4.60
C	0.15	0.25
D	—	0.20
E	6.00	6.80
G	0.30	0.70
H	0.90	1.10
J	—	1.50
K	3.80	4.20
L	1.22	1.72
All Dimensions in mm		

Mechanical Data

- Case: SOPA-4, ABS, Molded Plastic
- Terminals: Plated Leads Solderable per MIL-STD-202, Method 208
- Polarity: As Marked on Case
- Mounting Position: Any
- Marking: Type Number
- **Lead Free: For RoHS / Lead Free Version**

Maximum Ratings and Electrical Characteristics @T_A=25°C unless otherwise specified

Single Phase, half wave, 60Hz, resistive or inductive load.
For capacitive load, derate current by 20%.

Characteristic	Symbol	RABS	RABS	RABS	RABS	RABS	RABS	RABS	Unit
		205	21	22	24	26	28	210	
Peak Repetitive Reverse Voltage	V _{RRM}	50	100	200	400	600	800	1000	V
Working Peak Reverse Voltage	V _{RWM}								
DC Blocking Voltage	V _R								
RMS Reverse Voltage	V _{R(RMS)}	35	70	140	280	420	560	700	V
Average Rectified Output Current (Note 1) @T _A = 40°C	I _O	2.0							A
Average Rectified Output Current (Note 2) @T _A = 40°C									
Non-Repetitive Peak Forward Surge Current 8.3ms Single half sine-wave superimposed on rated load (JEDEC Method)	I _{FSM}	50							A
I ² t Rating for Fusing (t < 8.3ms)	I ² t	5.0							A ² s
Forward Voltage per element @I _F = 2.0A	V _{FM}	1.3							V
Peak Reverse Current @T _A = 25°C	I _{RM}	5.0							μA
At Rated DC Blocking Voltage @T _A = 125°C		500							
Reverse Recovery Time (Note 4)	t _{rr}	150				250	500		nS
Typical Junction Capacitance per leg (Note 3)	C _j	13							pF
Typical Thermal Resistance per leg (Note 1)	R _{θJA} R _{θJL}	62.5				25			°C/W
Operating and Storage Temperature Range	T _j , T _{STG}	-55 to +150							°C

Note: 1. Mounted on glass epoxy PC board with 1.3mm² solder pad.
2. Mounted on aluminum substrate PC board with 1.3mm² solder pad.
3. Measured at 1.0 MHz and applied reverse voltage of 4.0V D.C.
4. Measured with I_F = 0.5A, I_R = 1.0A, I_{RR} = 0.25A. See figure 5.

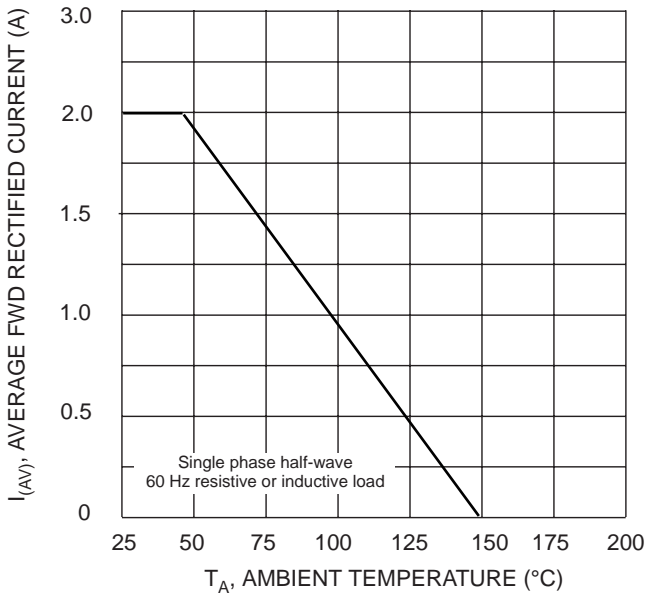

Fig. 1 Forward Derating Curve

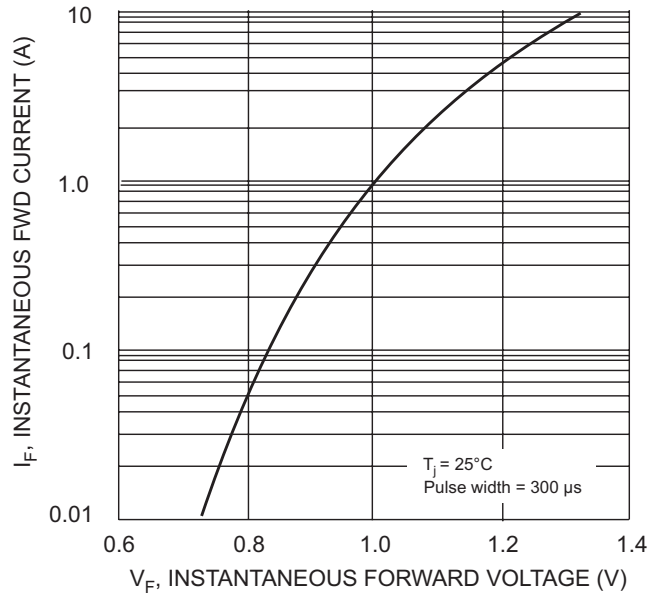

Fig. 2 Typical Forward Characteristics

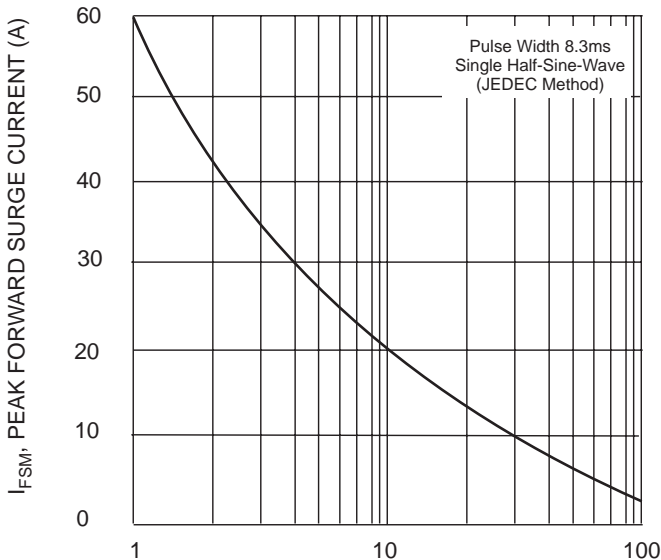

Fig. 3 Peak Forward Surge Current

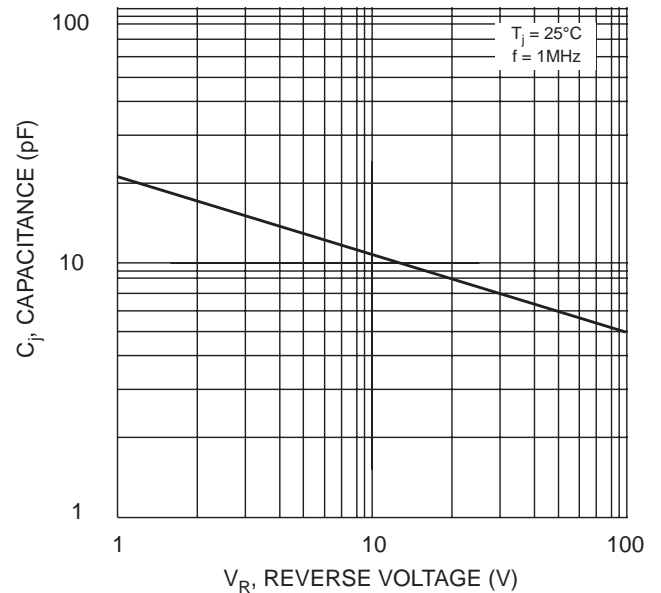
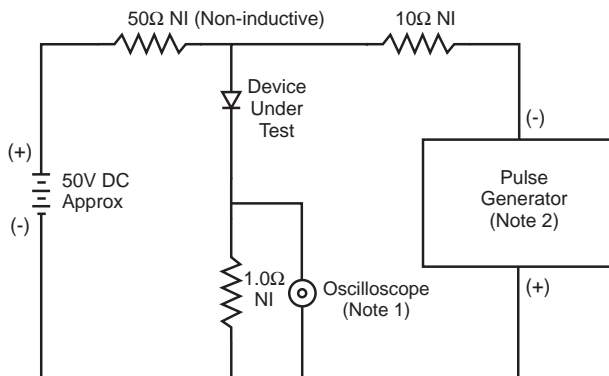
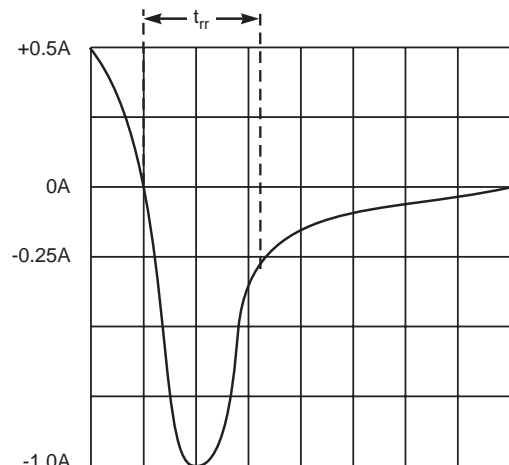

Fig. 4 Typical Junction Capacitance



- Notes:
1. Rise Time = 7.0ns max. Input Impedance = 1.0MΩ, 22pF.
 2. Rise Time = 10ns max. Input Impedance = 50Ω.



Set time base for 5/10ns/cm

5 Reverse Recovery Time Characteristic and Test Circuit