

Features

- Diffused Junction
- Low Forward Voltage Drop
- High Current Capability
- High Reliability
- High Surge Current Capability

Mechanical Data

- Case: R-6, Molded Plastic
- Terminals: Plated Leads Solderable per MIL-STD-202, Method 208
- Polarity: Cathode Band
- Weight: 2.1 grams (approx.)
- Mounting Position: Any
- Marking: Type Number
- **Lead Free: For RoHS / Lead Free Version**

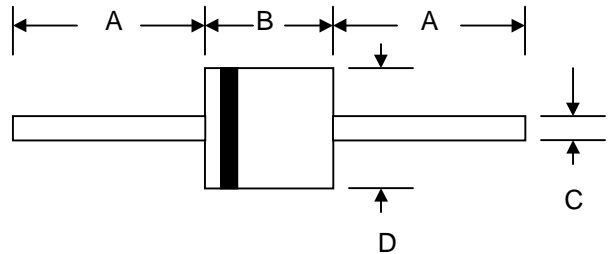

| R-6 | | |
|----------------------|------|------|
| Dim | Min | Max |
| A | 25.4 | — |
| B | 8.60 | 9.10 |
| C | 1.20 | 1.30 |
| D | 8.60 | 9.10 |
| All Dimensions in mm | | |

Maximum Ratings and Electrical Characteristics @ $T_A=25^\circ\text{C}$ unless otherwise specified

Single Phase, half wave, 60Hz, resistive or inductive load.
For capacitive load, derate current by 20%.

| Characteristic | Symbol | PR6001 | PR6002 | PR6003 | PR6004 | PR6005 | PR6006 | PR6007 | Unit |
|--|--------------|-----------------------------|--------|--------|--------|--------|--------|--------|------------------|
| Peak Repetitive Reverse Voltage | V_{RRM} | | | | | | | | |
| Working Peak Reverse Voltage | V_{RWM} | 50 | 100 | 200 | 400 | 600 | 800 | 1000 | V |
| DC Blocking Voltage | V_R | | | | | | | | |
| RMS Reverse Voltage | $V_{R(RMS)}$ | 35 | 70 | 140 | 280 | 420 | 560 | 700 | V |
| Average Rectified Output Current (Note 1) | I_O | 6.0 | | | | | | | A |
| | | @ $T_A = 55^\circ\text{C}$ | | | | | | | |
| Non-Repetitive Peak Forward Surge Current 8.3ms Single half sine-wave superimposed on rated load (JEDEC Method) | I_{FSM} | 300 | | | | | | | A |
| Forward Voltage | V_{FM} | 1.28 | | | | | | | V |
| | | @ $I_F = 6.0\text{A}$ | | | | | | | |
| Peak Reverse Current | I_{RM} | 2.0 | | | | | | | μA |
| At Rated DC Blocking Voltage | | 200 | | | | | | | |
| | | @ $T_A = 100^\circ\text{C}$ | | | | | | | |
| Reverse Recovery Time (Note 2) | t_{rr} | 150 | | | 250 | | 450 | | nS |
| Typical Junction Capacitance (Note 3) | C_j | 100 | | | | | | | pF |
| Operating Temperature Range | T_j | -55 to +150 | | | | | | | $^\circ\text{C}$ |
| Storage Temperature Range | T_{STG} | -55 to +150 | | | | | | | $^\circ\text{C}$ |

Note: 1. Leads maintained at ambient temperature at a distance of 9.5mm from the case
2. Measured with $I_F = 0.5\text{A}$, $I_R = 1.0\text{A}$, $IRR = 0.25\text{A}$. See figure 5.
3. Measured at 1.0 MHz and applied reverse voltage of 4.0V D.C.

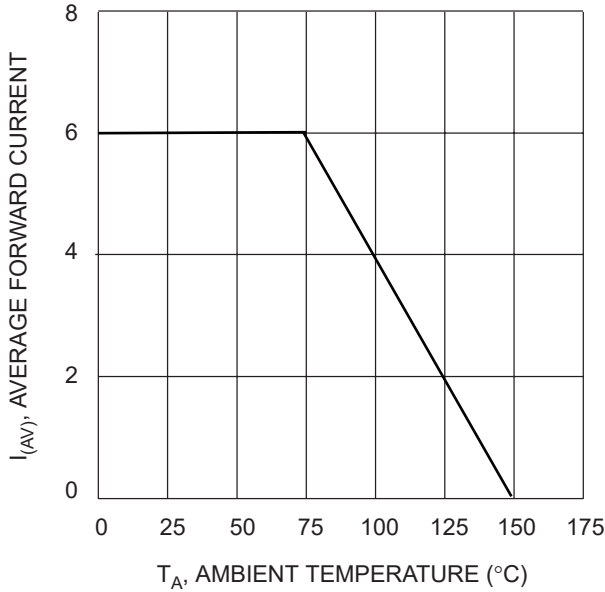

Fig. 1, Typical Forward Current Derating Curve

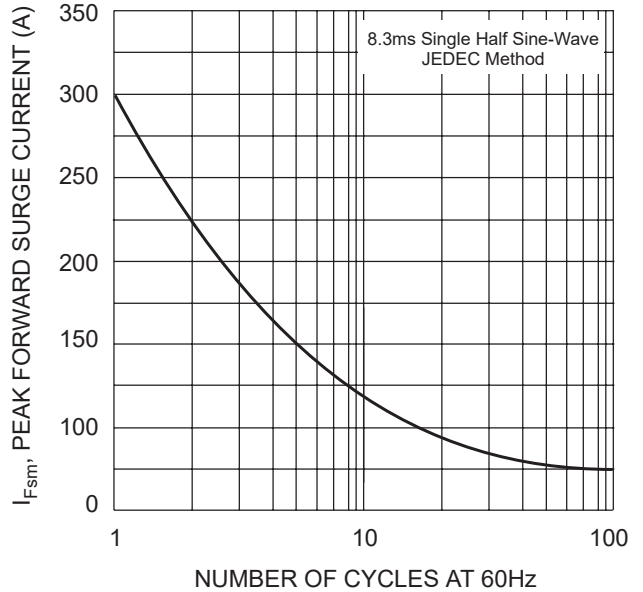

Fig. 2 Max Non-Repetitive Peak Surge Current

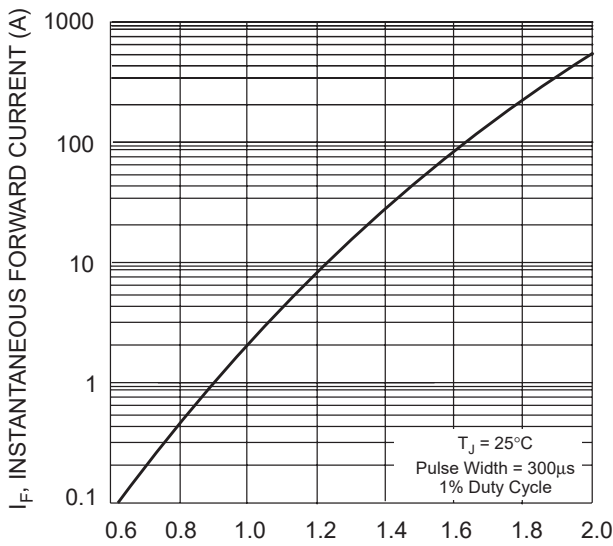

Fig. 3, Typical Instantaneous Forward Characteristics

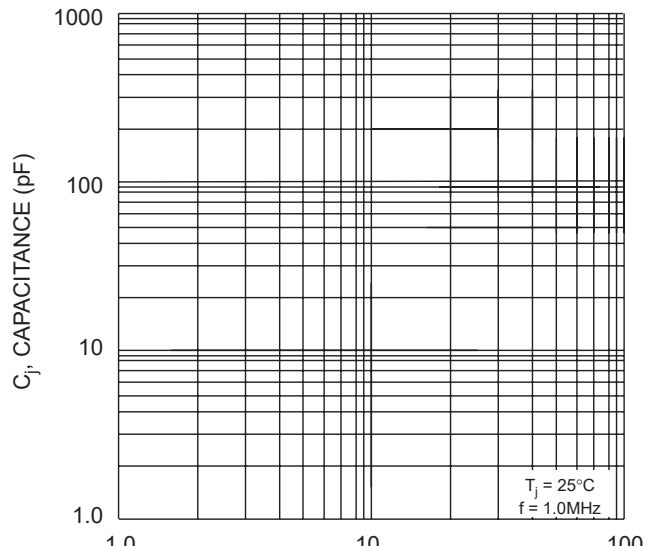
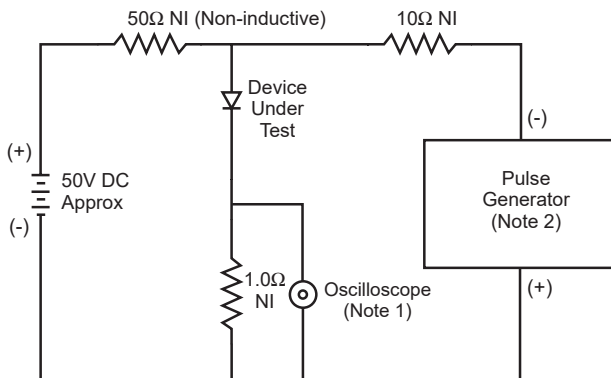

Fig. 4 Typical Junction Capacitance



- Notes:
1. Rise Time = 7.0ns max. Input Impedance = 1.0MΩ, 22pF.
 2. Rise Time = 10ns max. Input Impedance = 50Ω.

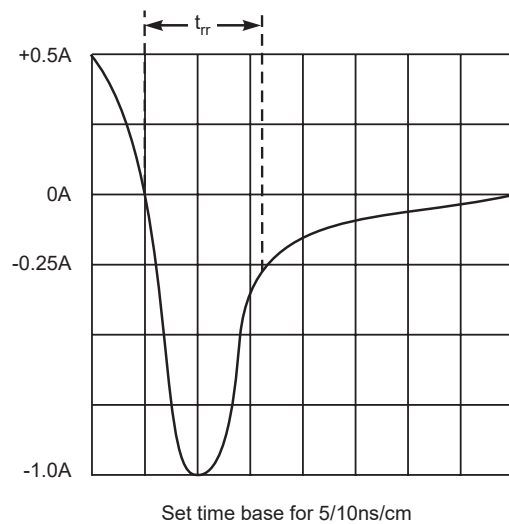

Fig. 5 Reverse Recovery Time Characteristic and Test Circuit