

#### Features

- Glass Passivated Die Construction
- Low Forward Voltage Drop
- High Current Capability
- High Reliability
- High Surge Current Capability

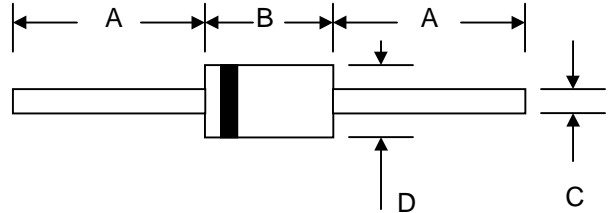

#### Mechanical Data

- Case: DO - 201AD, Molded Plastic
- Terminals: Plated Leads Solderable per MIL-STD-202, Method 208
- Polarity: Cathode Band
- Weight: 2.1 grams (approx.)
- Mounting Position: Any
- Marking: Type Number
- **Lead Free: For RoHS / Lead Free Version**

DO-201AD		
Dim	Min	Max
A	24.5	—
B	7.20	9.50
C	1.10	1.30
D	5.00	5.60
All Dimensions in mm		

#### Maximum Ratings and Electrical Characteristics @ $T_A=25^\circ\text{C}$ unless otherwise specified

Single Phase, half wave, 60Hz, resistive or inductive load.  
For capacitive load, derate current by 20%.

Characteristic	Symbol	PR5001G	PR5002G	PR5003G	PR5004G	PR5005G	PR5006G	PR5007G	Unit
Peak Repetitive Reverse Voltage	$V_{RRM}$								
Working Peak Reverse Voltage	$V_{RWM}$	50	100	200	400	600	800	1000	V
DC Blocking Voltage	$V_R$								
RMS Reverse Voltage	$V_{R(RMS)}$	35	70	140	280	420	560	700	V
Average Rectified Output Current (Note 1)	$I_O$	5.0							A
		@ $T_A = 55^\circ\text{C}$							
Non-Repetitive Peak Forward Surge Current 8.3ms Single half sine-wave superimposed on rated load (JEDEC Method)	$I_{FSM}$	300							A
Forward Voltage	$V_{FM}$	1.28							V
		@ $I_F = 5.0\text{A}$							
Peak Reverse Current	$I_{RM}$	2.0							$\mu\text{A}$
		@ $T_A = 25^\circ\text{C}$							
At Rated DC Blocking Voltage	$I_{RM}$	200							$\mu\text{A}$
		@ $T_A = 100^\circ\text{C}$							
Reverse Recovery Time (Note 2)	$t_{rr}$	150			250	450			nS
Typical Junction Capacitance (Note 3)	$C_j$	100							pF
Operating Temperature Range	$T_j$	-55 to +150							$^\circ\text{C}$
Storage Temperature Range	$T_{STG}$	-55 to +150							$^\circ\text{C}$

Note: 1. Leads maintained at ambient temperature at a distance of 9.5mm from the case  
2. Measured with  $I_F = 0.5\text{A}$ ,  $I_R = 1.0\text{A}$ ,  $IRR = 0.25\text{A}$ . See figure 5.  
3. Measured at 1.0 MHz and applied reverse voltage of 4.0V D.C.

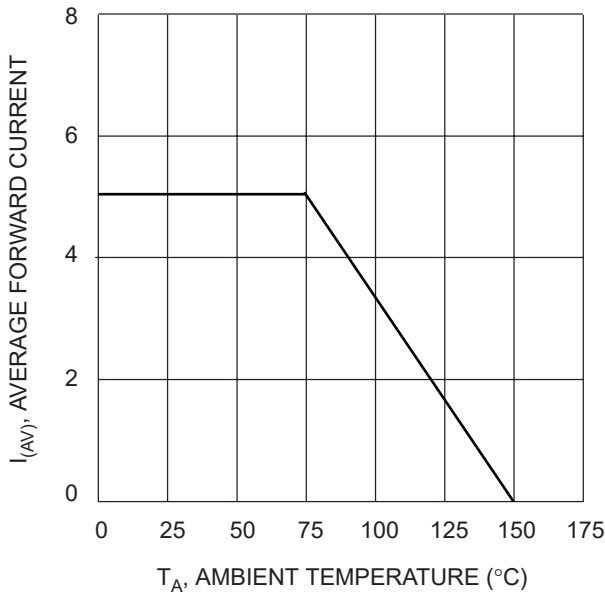

Fig. 1, Typical Forward Current Derating Curve

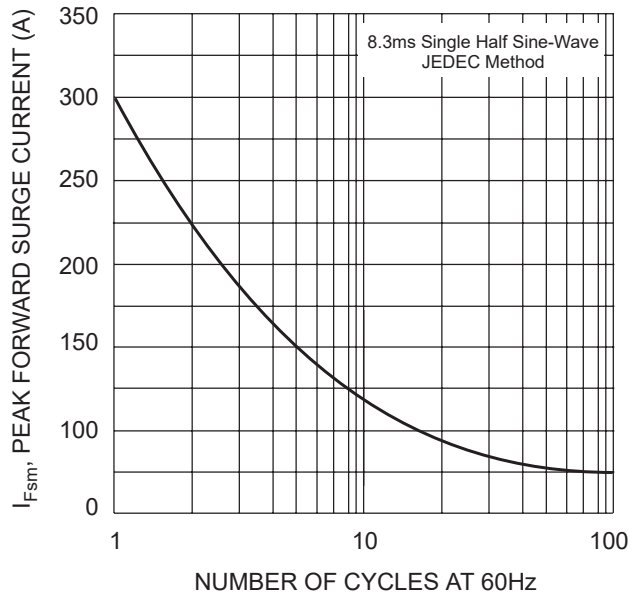

Fig. 2 Max Non-Repetitive Peak Surge Current

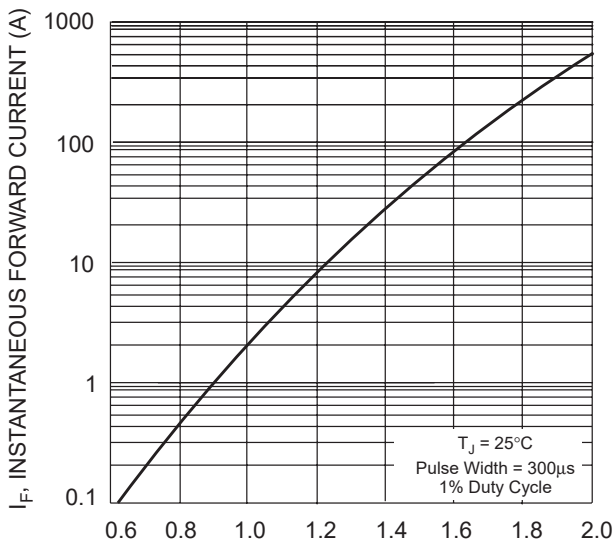

Fig. 3, Typical Instantaneous Forward Characteristics

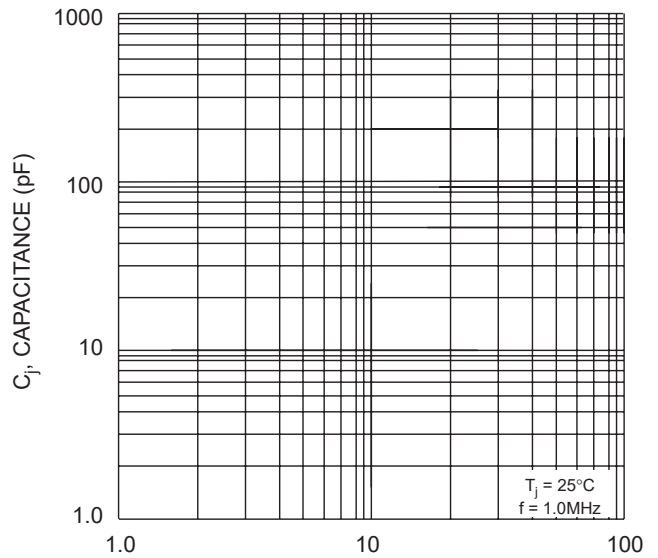
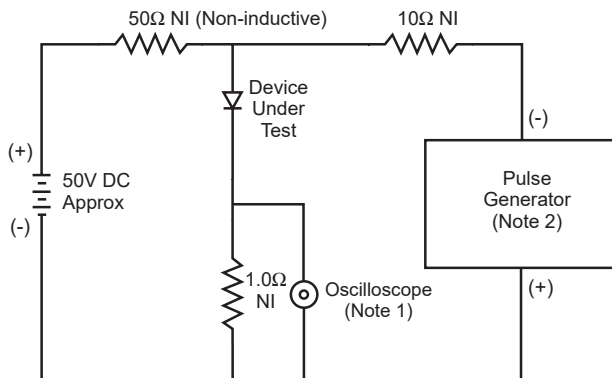

Fig. 4 Typical Junction Capacitance



- Notes:
1. Rise Time = 7.0ns max. Input Impedance = 1.0MΩ, 22pF.
  2. Rise Time = 10ns max. Input Impedance = 50Ω.

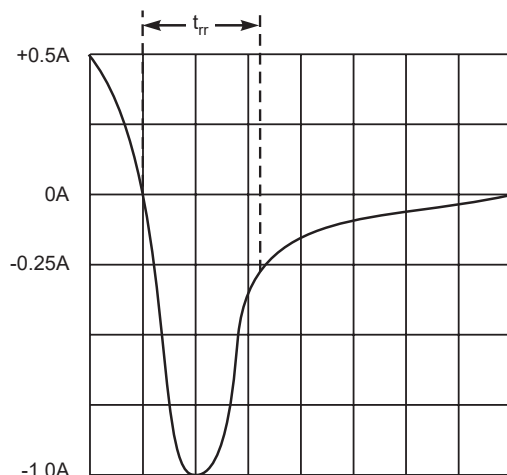

Fig. 5 Reverse Recovery Time Characteristic and Test Circuit