

Features

- Diffused Junction
- Low Forward Voltage Drop
- High Current Capability
- High Reliability
- High Surge Current Capability

Mechanical Data

- Case: Molded Plastic
- Terminals: Plated Leads Solderable per MIL-STD-202, Method 208
- Polarity: Cathode Band
- Weight: 1.2 grams (approx.)
- Mounting Position: Any
- Marking: Type Number
- Epoxy: UL 94V-O rate flame retardant
- **Lead Free: For RoHS / Lead Free Version**

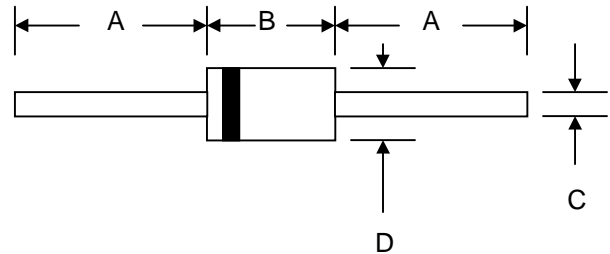

| DO-201AD | | |
|----------------------|------|------|
| Dim | Min | Max |
| A | 24.5 | — |
| B | 7.20 | 9.50 |
| C | 1.10 | 1.30 |
| D | 5.00 | 5.60 |
| All Dimensions in mm | | |

Maximum Ratings and Electrical Characteristics @ $T_A=25^\circ\text{C}$ unless otherwise specified

Single Phase, half wave, 60Hz, resistive or inductive load.
For capacitive load, derate current by 20%.

| Characteristic | Symbol | PR3001G | PR3002G | PR3003G | PR3004G | PR3005G | PR3006G | PR3007G | Unit |
|---|--------------|-------------|---------|---------|---------|---------|---------|---------|------------------|
| Peak Repetitive Reverse Voltage | V_{RRM} | | | | | | | | V |
| Working Peak Reverse Voltage | V_{RWM} | 50 | 100 | 200 | 400 | 600 | 800 | 1000 | |
| DC Blocking Voltage | V_R | | | | | | | | |
| RMS Reverse Voltage | $V_{R(RMS)}$ | 35 | 70 | 140 | 280 | 420 | 560 | 700 | V |
| Average Rectified Output Current (Note 1) @ $T_A = 55^\circ\text{C}$ | I_o | 3.0 | | | | | | | A |
| Non-Repetitive Peak Forward Surge Current 8.3ms Single half sine-wave superimposed on rated load (JEDEC Method) | I_{FSM} | 125 | | | | | | | A |
| Forward Voltage @ $I_F = 3.0\text{A}$ | V_{FM} | 1.28 | | | | | | | V |
| Peak Reverse Current @ $T_A = 25^\circ\text{C}$ At Rated DC Blocking Voltage @ $T_A = 100^\circ\text{C}$ | I_{RM} | 2.0 150 | | | | | | | μA |
| Reverse Recovery Time (Note 2) | t_{rr} | 150 | | | | 250 | 450 | | nS |
| Typical Junction Capacitance (Note 3) | C_j | 60 | | | | | | | pF |
| Operating Temperature Range | T_j | -55 to +150 | | | | | | | $^\circ\text{C}$ |
| Storage Temperature Range | T_{STG} | -55 to +150 | | | | | | | $^\circ\text{C}$ |

Note: 1. Leads maintained at ambient temperature at a distance of 9.5mm from the case
2. Measured with $I_F = 0.5\text{A}$, $I_R = 1.0\text{A}$, $IRR = 0.25\text{A}$. See figure 5.
3. Measured at 1.0 MHz and applied reverse voltage of 4.0V D.C.

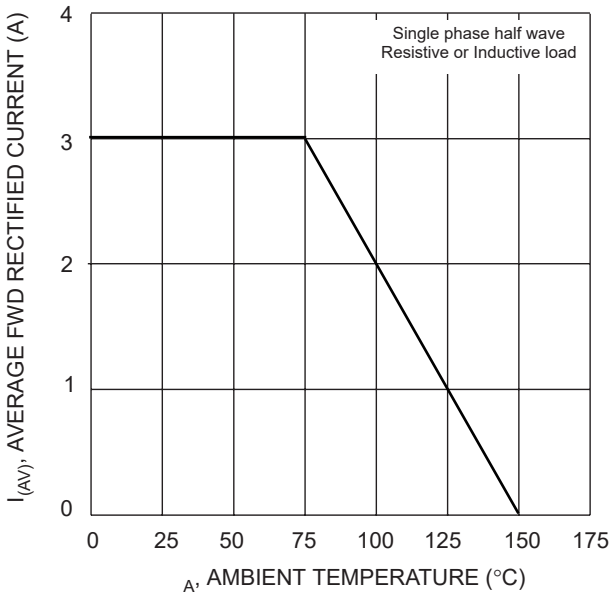

Fig. 1 Forward Derating Curve

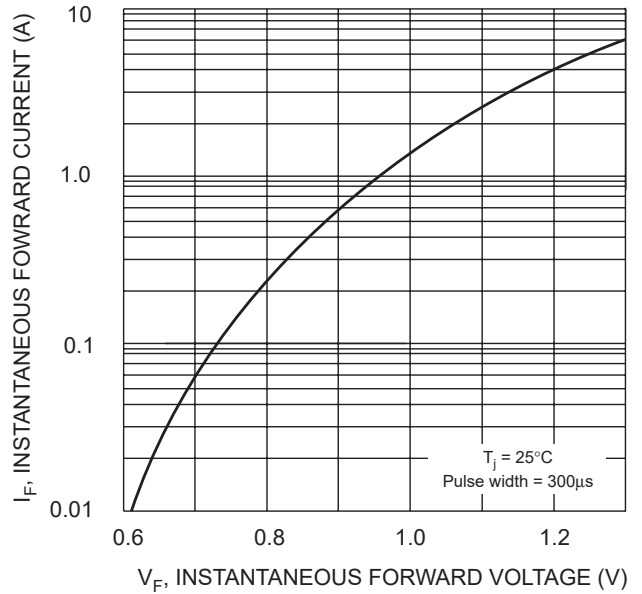

Fig. 2 Typical Forward Characteristics

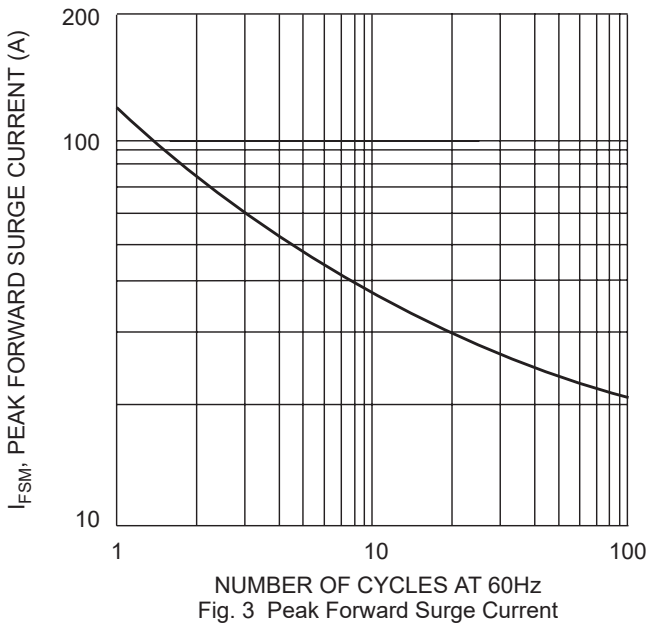

Fig. 3 Peak Forward Surge Current

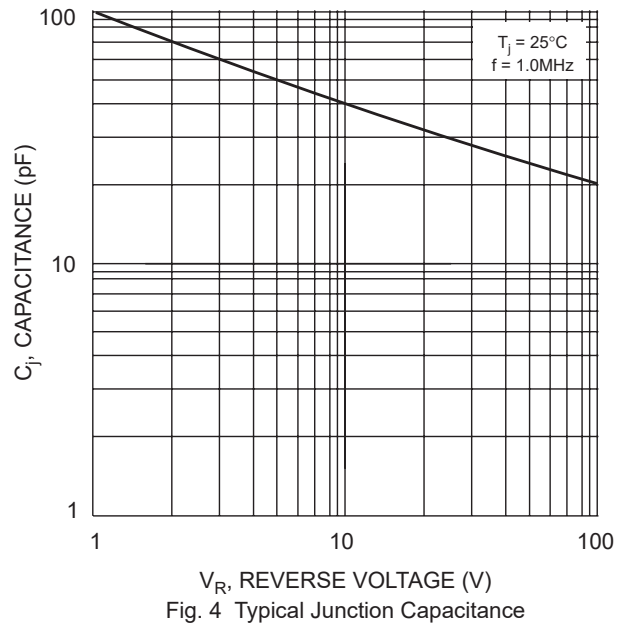
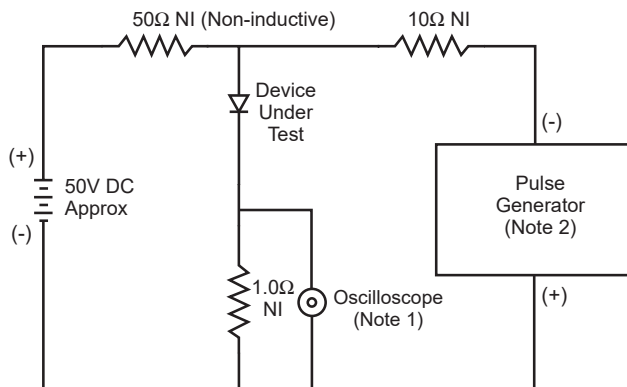
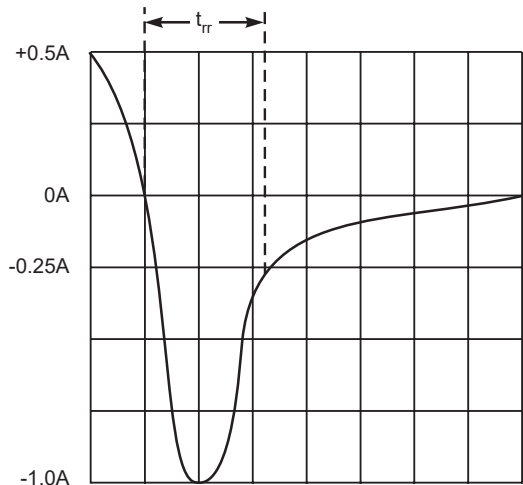

Fig. 4 Typical Junction Capacitance



- Notes:
1. Rise Time = 7.0ns max. Input Impedance = 1.0MΩ, 22pF.
 2. Rise Time = 10ns max. Input Impedance = 50Ω.



Set time base for 5/10ns/cm

Fig. 5 Reverse Recovery Time Characteristic and Test Circuit