

#### Features

- Diffused Junction
- Low Forward Voltage Drop
- High Current Capability
- High Reliability
- High Surge Current Capability

#### Mechanical Data

- Case: Molded Plastic
- Terminals: Plated Leads Solderable per MIL-STD-202, Method 208
- Polarity: Cathode Band
- Weight: 1.2 grams (approx.)
- Mounting Position: Any
- Marking: Type Number
- Epoxy: UL 94V-O rate flame retardant
- **Lead Free: For RoHS / Lead Free Version**

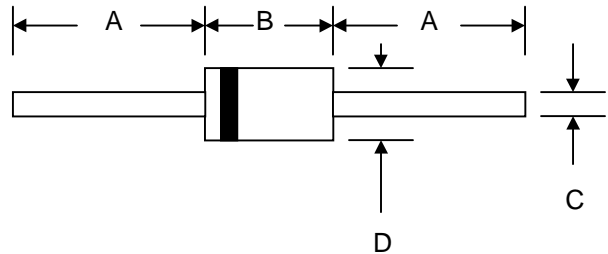

| DO-201AD             |      |      |
|----------------------|------|------|
| Dim                  | Min  | Max  |
| A                    | 24.5 | —    |
| B                    | 7.20 | 9.50 |
| C                    | 1.10 | 1.30 |
| D                    | 5.00 | 5.60 |
| All Dimensions in mm |      |      |

#### Maximum Ratings and Electrical Characteristics @ $T_A=25^\circ\text{C}$ unless otherwise specified

Single Phase, half wave, 60Hz, resistive or inductive load.  
For capacitive load, derate current by 20%.

| Characteristic   | Symbol       | FR301G      | FR302G | FR303G | FR304G | FR305G | FR306G | FR307G | Unit             |
|--|--------------|-------------|--------|--------|--------|--------|--------|--------|------------------|
| Peak Repetitive Reverse Voltage  | $V_{RRM}$    |             |        |        |        |        |        |        | V                |
| Working Peak Reverse Voltage   | $V_{RWM}$    | 50          | 100    | 200    | 400    | 600    | 800    | 1000   |                  |
| DC Blocking Voltage  | $V_R$        |             |        |        |        |        |        |        |                  |
| RMS Reverse Voltage  | $V_{R(RMS)}$ | 35          | 70     | 140    | 280    | 420    | 560    | 700    | V                |
| Average Rectified Output Current (Note 1)<br>@ $T_A = 55^\circ\text{C}$  | $I_o$        | 3.0         |        |        |        |        |        |        | A                |
| Non-Repetitive Peak Forward Surge Current<br>8.3ms Single half sine-wave superimposed on rated load (JEDEC Method) | $I_{FSM}$    | 125         |        |        |        |        |        |        | A                |
| Forward Voltage<br>@ $I_F = 3.0\text{A}$   | $V_{FM}$     | 1.28        |        |        |        |        |        |        | V                |
| Peak Reverse Current<br>At Rated DC Blocking Voltage<br>@ $T_A = 25^\circ\text{C}$<br>@ $T_A = 100^\circ\text{C}$  | $I_{RM}$     | 2.0<br>150  |        |        |        |        |        |        | $\mu\text{A}$    |
| Reverse Recovery Time (Note 2)   | $t_{rr}$     | 150         |        |        |        | 250    | 450    |        | nS               |
| Typical Junction Capacitance (Note 3)  | $C_j$        | 60          |        |        |        |        |        |        | pF               |
| Operating Temperature Range  | $T_j$        | -55 to +150 |        |        |        |        |        |        | $^\circ\text{C}$ |
| Storage Temperature Range  | $T_{STG}$    | -55 to +150 |        |        |        |        |        |        | $^\circ\text{C}$ |

#### \*Glass passivated forms are available upon request

Note: 1. Leads maintained at ambient temperature at a distance of 9.5mm from the case

2. Measured with  $I_F = 0.5\text{A}$ ,  $I_R = 1.0\text{A}$ ,  $IRR = 0.25\text{A}$ . See figure 5.

3. Measured at 1.0 MHz and applied reverse voltage of 4.0V D.C.

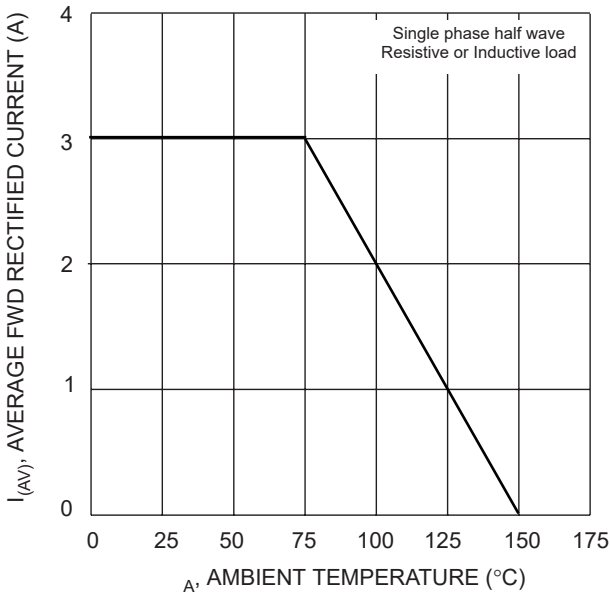

Fig. 1 Forward Derating Curve

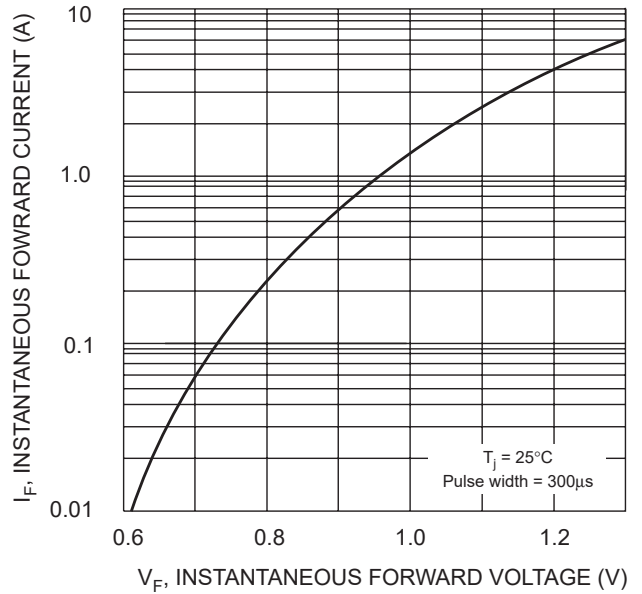

Fig. 2 Typical Forward Characteristics

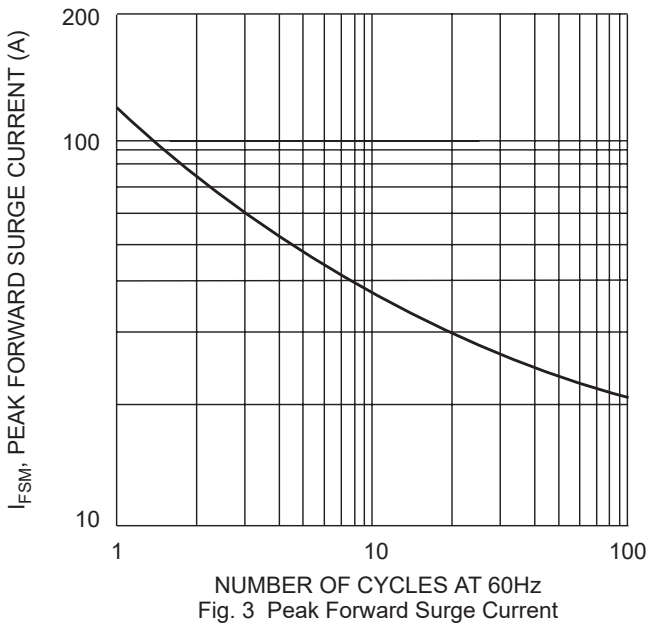

Fig. 3 Peak Forward Surge Current

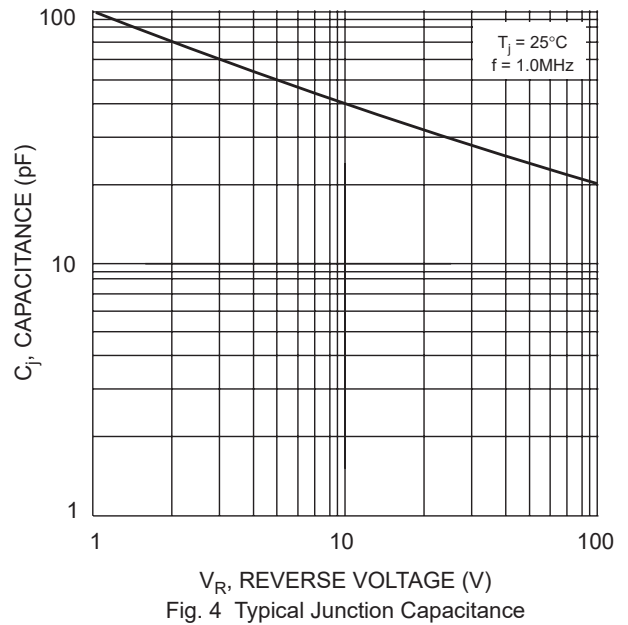
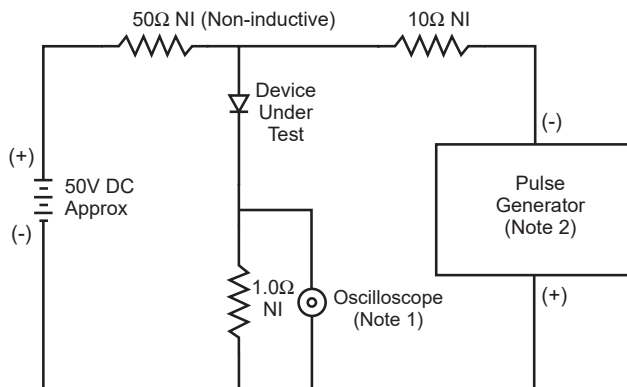
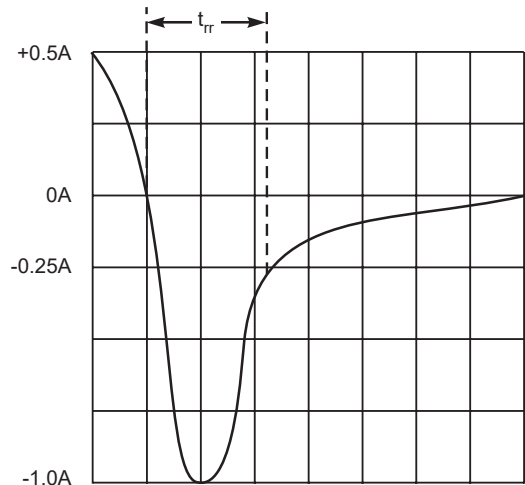

Fig. 4 Typical Junction Capacitance



- Notes:
1. Rise Time = 7.0ns max. Input Impedance = 1.0MΩ, 22pF.
  2. Rise Time = 10ns max. Input Impedance = 50Ω.



Set time base for 5/10ns/cm

Fig. 5 Reverse Recovery Time Characteristic and Test Circuit