

Features

- Glass passivated device
- Ideally Suited for Automatic Assembly
- Low Forward Voltage Drop, High Efficiency
- Surge Overload Rating to 25 A Peak
- Low Power Loss
- Ultra-Fast Recovery Time
- Plastic Case Material has UL Flammability
- Classification Rating 94V-O

Mechanical Data

- Case: SOD-123FL, Molded Plastic
- Terminals: Solder Plated, Solderable per MIL-STD-750, Method 2026
- Polarity: Cathode Band or Cathode Notch
- Marking: Type Number
- Weight: 0.01 grams (approx.)
- **Lead Free: For RoHS / Lead Free Version**

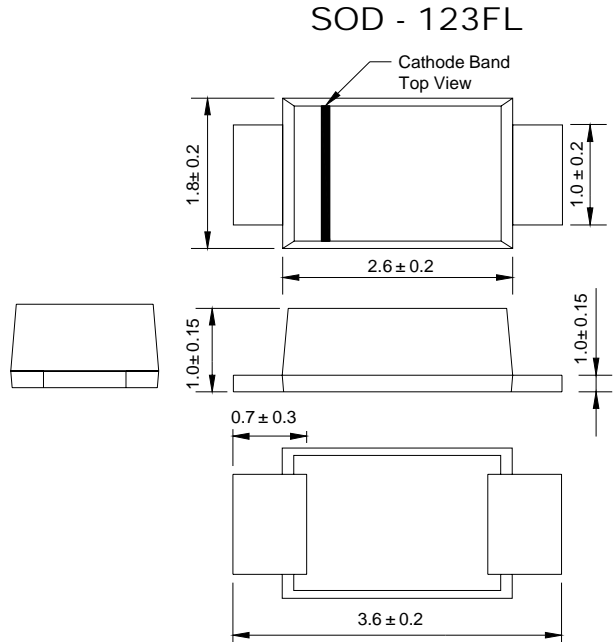

Dimensions in millimeters

Maximum Ratings and Electrical Characteristics @T_A=25°C unless otherwise specified

Characteristic	Symbol	FFM 101	FFM 102	FFM 103	FFM 104	FFM 105	FFM 106	FFM 107	UNITS
Peak Repetitive Reverse Voltage	V _{RRM}	50	100	200	400	600	800	1000	V
Working Peak Reverse Voltage	V _{RWM}								
DC Blocking Voltage	V _R								
RMS Reverse Voltage	V _{R(RMS)}	35	70	140	280	420	560	800	V
Average Rectified Output Current @T _L = 100°C	I _O	1.0							A
Non-Repetitive Peak Forward Surge Current 8.3ms Single half sine-wave superimposed on rated load (JEDEC Method)	I _{FSM}	25							A
Forward Voltage @I _F = 1.0A	V _{FM}	1.3							V
Peak Reverse Current @T _A = 25°C	I _{RM}	2.0							μA
At Rated DC Blocking Voltage @T _A = 100°C		50							
Reverse Recovery Time (Note 2)	t _{rr}	150			250	450		nS	
Typical Junction Capacitance (Note 2)	C _j	4							pF
Typical Thermal Resistance (Note 3)	R _{θJL}	180							°C/W
Operating and Storage Temperature Range	T _j , T _{STG}	-55 to +150							°C

- Note: 1. Measured with I_F = 0.5A, I_R = 1.0A, I_{rr} = 0.25A. See figure 5.
 2. Measured at 1.0 MHz and applied reverse voltage of 4.0 V DC.
 3. Mounted on P.C. Board with 8.0mm² land area.

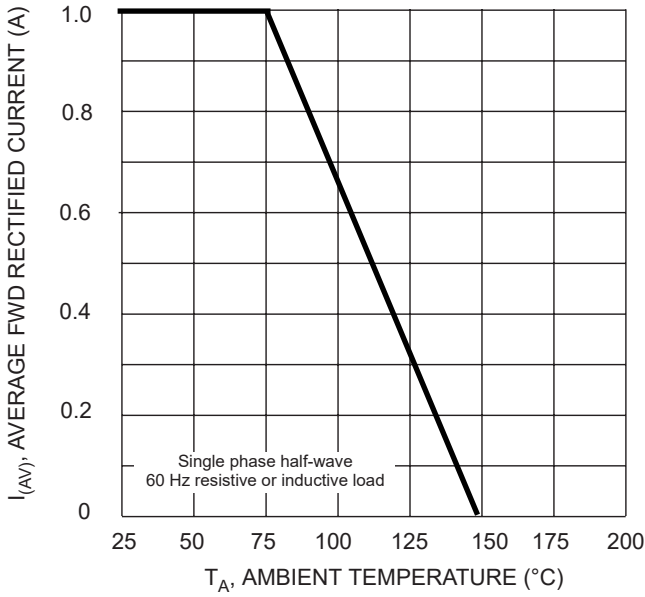

Fig. 1 Forward Derating Curve

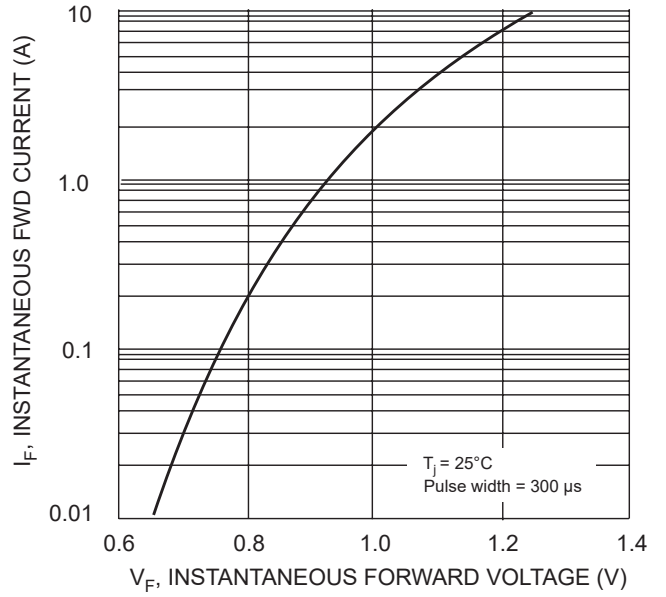

Fig. 2 Typical Forward Characteristics

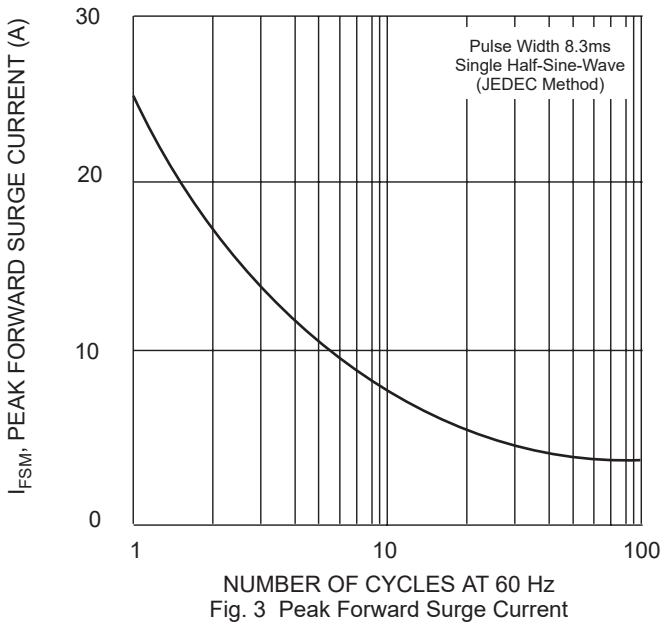

Fig. 3 Peak Forward Surge Current

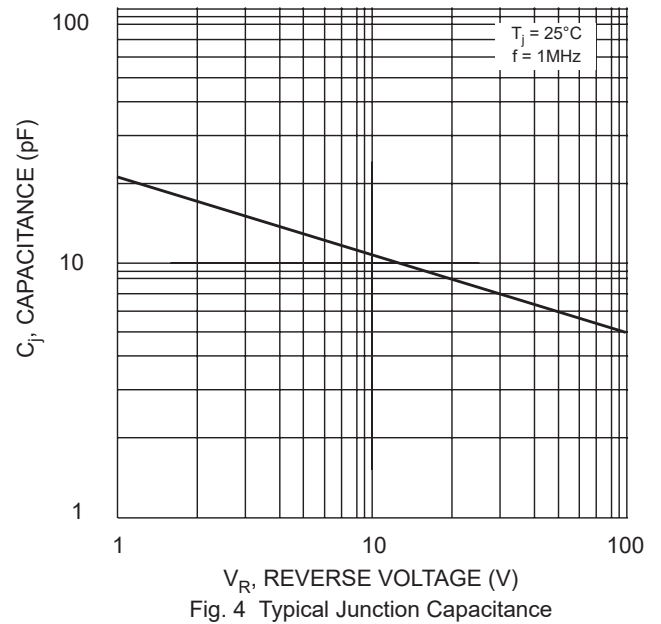
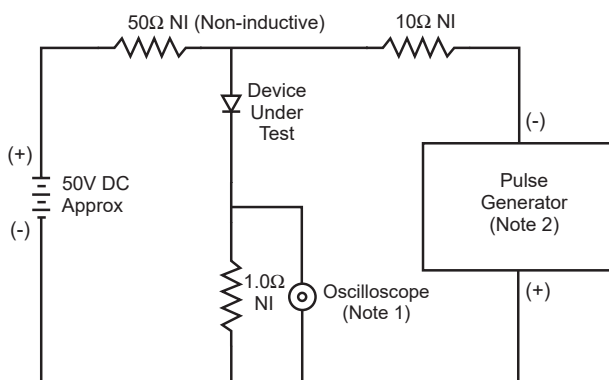
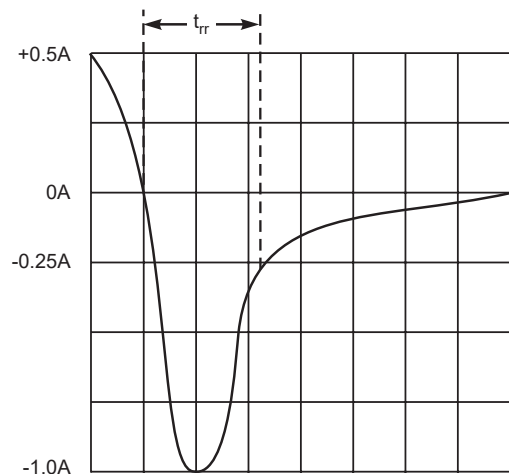

Fig. 4 Typical Junction Capacitance



- Notes:
1. Rise Time = 7.0ns max. Input Impedance = 1.0MΩ, 22pF.
 2. Rise Time = 10ns max. Input Impedance = 50Ω.



Set time base for 5/10ns/cm

Fig. 5 Reverse Recovery Time Characteristic and Test Circuit