

Features

- Glass Passivated Die Construction
- Ideally Suited for Automatic Assembly
- Low Forward Voltage Drop, High Efficiency
- Surge Overload Rating to 100A Peak
- Low Power Loss
- Super-Fast Recovery Time
- Plastic Case Material has UL Flammability Classification Rating 94V-0

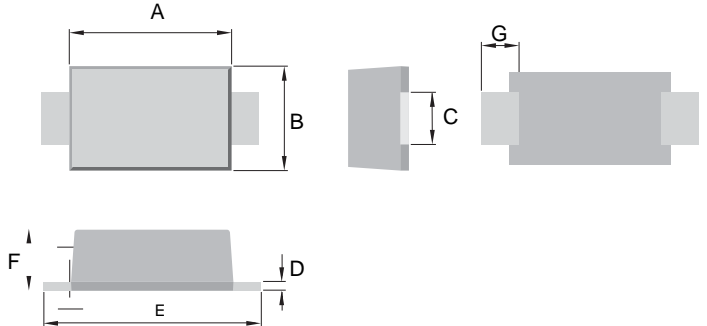

Mechanical Data

- Case: SMAF, Molded Plastic
- Terminals: Solder Plated, Solderable per MIL-STD-750, Method 2026
- Polarity: Cathode Band or Cathode Notch
- Marking: Type Number
- Weight: 0.037 grams (approx.)
- **Lead Free: For RoHS / Lead Free Version**

SMAF		
Dim	Min	Max
A	3.20	3.60
B	2.40	2.80
C	1.38	1.43
D	0.10	0.20
E	4.40	4.80
F	0.90	1.10
G	0.90	-
All Dimensions in mm		

Maximum Ratings and Electrical Characteristics @ $T_A=25^\circ\text{C}$ unless otherwise specified

Characteristic	Symbol	ES3AF	ES3BF	ES3CF	ES3DF	ES3EF	ES3GF	ES3JF	Unit
Peak Repetitive Reverse Voltage	V_{RRM}								
Working Peak Reverse Voltage	V_{RWM}	50	100	150	200	300	400	600	V
DC Blocking Voltage	V_R								
RMS Reverse Voltage	$V_{R(RMS)}$	35	70	105	140	210	280	420	V
Average Rectified Output Current @ $T_L = 100^\circ\text{C}$	I_O	3.0							A
Non-Repetitive Peak Forward Surge Current 8.3ms Single half sine-wave superimposed on rated load (JEDEC Method)	I_{FSM}	100							A
Forward Voltage @ $I_F = 3.0\text{A}$	V_{FM}	0.95				1.25		1.7	V
Peak Reverse Current @ $T_A = 25^\circ\text{C}$ At Rated DC Blocking Voltage @ $T_A = 100^\circ\text{C}$	I_{RM}					5.0		100	μA
Reverse Recovery Time (Note 1)	t_{rr}					35			nS
Typical Junction Capacitance (Note 2)	C_j					45			pF
Typical Thermal Resistance (Note 3)	$R_{\theta JL}$					60			$^\circ\text{C/W}$
Operating and Storage Temperature Range	T_j, T_{STG}	-65 to +150							$^\circ\text{C}$

Note: 1. Measured with $I_F = 0.5\text{A}$, $I_R = 1.0\text{A}$, $I_{rr} = 0.25\text{A}$. See figure 5.
 2. Measured at 1.0 MHz and applied reverse voltage of 4.0 V DC.
 3. Mounted on P.C. Board with 8.0mm² land area.

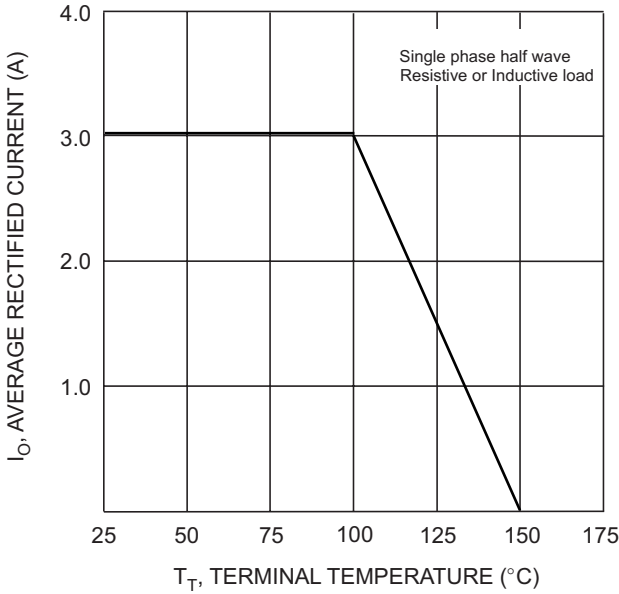

Fig. 1 Forward Current Derating Curve

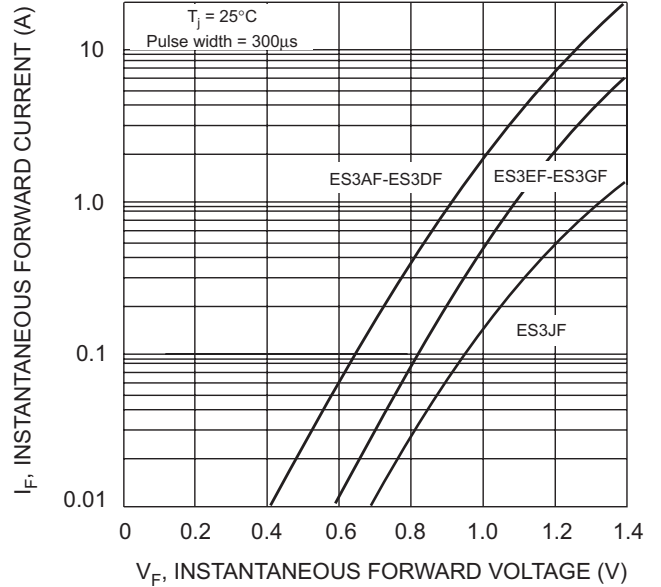

Fig. 2 Typical Forward Characteristics

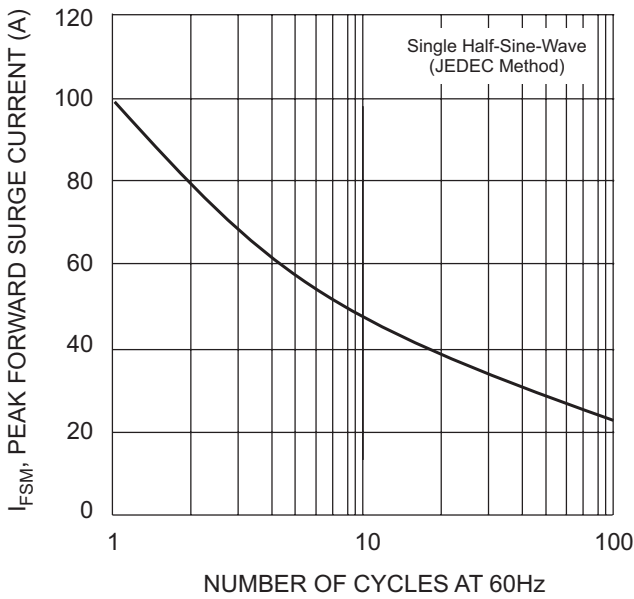

Fig. 3 Surge Current Derating Curve

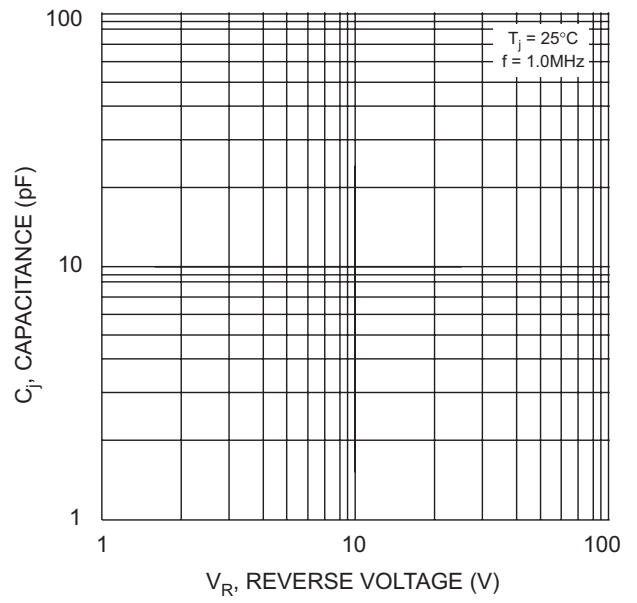
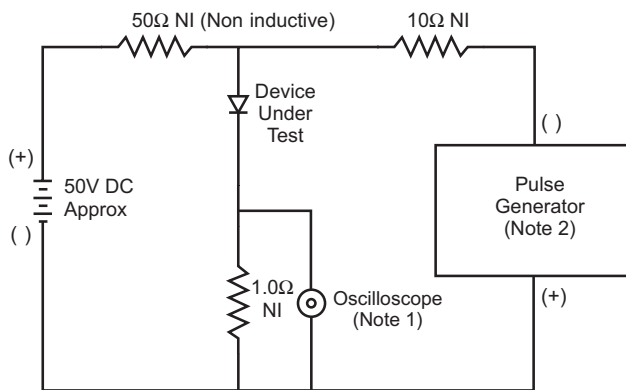
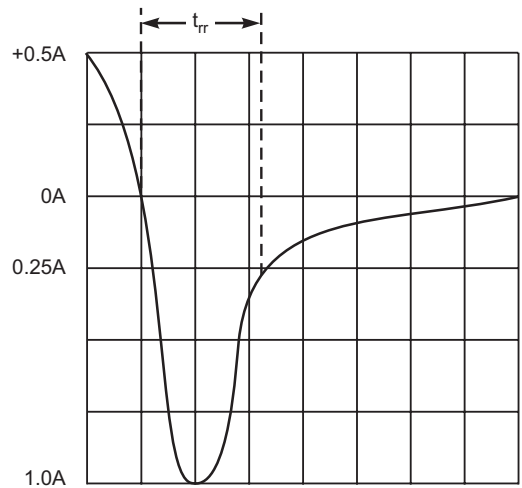

Fig. 4 Typical Junction Capacitance



Notes:

1. Rise Time = 7.0ns max. Input Impedance = 1.0MΩ, 22pF.
2. Rise Time = 10ns max. Input Impedance = 50Ω.



Set time base for 5/10ns/cm

Fig. 5 Reverse Recovery Time Characteristic and Test Circuit