

### 1.0A SUPER FAST SURFACE MOUNT GLASS PASSIVATED BRIDGE RECTIFIER

#### Features

- Glass Passivated Die Construction
- Low Forward Voltage Drop
- High Current Capability
- High Surge Current Capability
- Designed for Surface Mount Application
- Plastic Material – UL Flammability 94V-O

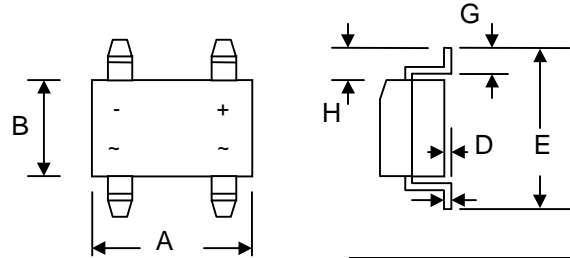

#### Mechanical Data

- Case: MB-F, Molded Plastic
- Terminals: Plated Leads Solderable per MIL-STD-202, Method 208
- Polarity: As Marked on Case
- Weight: 0.134 grams (approx.)
- Mounting Position: Any
- Marking: Type Number
- **Lead Free: For RoHS / Lead Free Version**

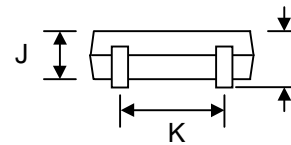

MB-F		
Dim	Min	Max
A	4.50	4.95
B	3.60	4.10
C	0.15	0.35
D	—	0.20
E	6.40	7.00
G	0.50	1.10
H	1.30	1.70
J	1.20	1.60
K	2.30	2.70
L	—	1.80
All Dimensions in mm		

#### Maximum Ratings and Electrical Characteristics @T<sub>A</sub>=25°C unless otherwise specified

Single Phase, half wave, 60Hz, resistive or inductive load.  
For capacitive load, derate current by 20%.

Characteristic	Symbol	EMB1F	EMB2F	EMB4F	EMB6F	Unit
Peak Repetitive Reverse Voltage	V <sub>RRM</sub>					
Working Peak Reverse Voltage	V <sub>RWM</sub>	100	200	400	600	V
DC Blocking Voltage	V <sub>R</sub>					
RMS Reverse Voltage	V <sub>R(RMS)</sub>	70	140	280	560	V
Average Rectified Output Current (Note 1) @T <sub>A</sub> = 40°C	I <sub>O</sub>	1.0				A
Average Rectified Output Current (Note 2) @T <sub>A</sub> = 40°C						
Non-Repetitive Peak Forward Surge Current 8.3ms Single half sine-wave superimposed on rated load (JEDEC Method)	I <sub>FSM</sub>	35				A
I <sup>2</sup> t Rating for Fusing (t < 8.3ms)	I <sup>2</sup> t	5.0				A <sup>2</sup> s
Forward Voltage per element @I <sub>F</sub> = 1.0A	V <sub>FM</sub>	0.95		1.25	1.7	V
Peak Reverse Current @T <sub>A</sub> = 25°C	I <sub>RM</sub>	5.0				μA
At Rated DC Blocking Voltage @T <sub>A</sub> = 125°C		500				
Reverse Recovery Time (Note 4)	t <sub>rr</sub>	35				nS
Typical Junction Capacitance per leg (Note 3)	C <sub>j</sub>	13				pF
Typical Thermal Resistance per leg (Note 1)	R <sub>θJA</sub> R <sub>θJL</sub>	62.5 25				°C/W
Operating and Storage Temperature Range	T <sub>j</sub> , T <sub>STG</sub>	-55 to +150				°C

Note: 1. Mounted on glass epoxy PC board with 1.3mm<sup>2</sup> solder pad.  
2. Mounted on aluminum substrate PC board with 1.3mm<sup>2</sup> solder pad.  
3. Measured at 1.0 MHz and applied reverse voltage of 4.0V D.C.  
4. Measured with I<sub>F</sub> = 0.5A, I<sub>R</sub> = 1.0A, I<sub>RR</sub> = 0.25A. See figure 5.

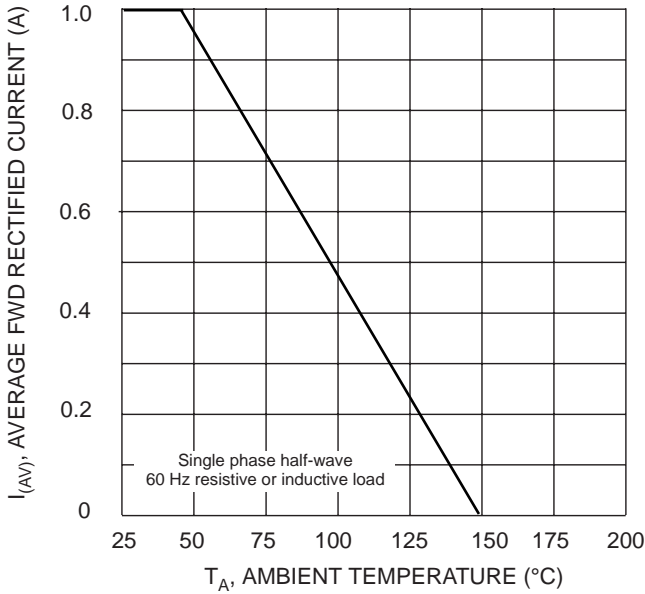

Fig. 1 Forward Derating Curve

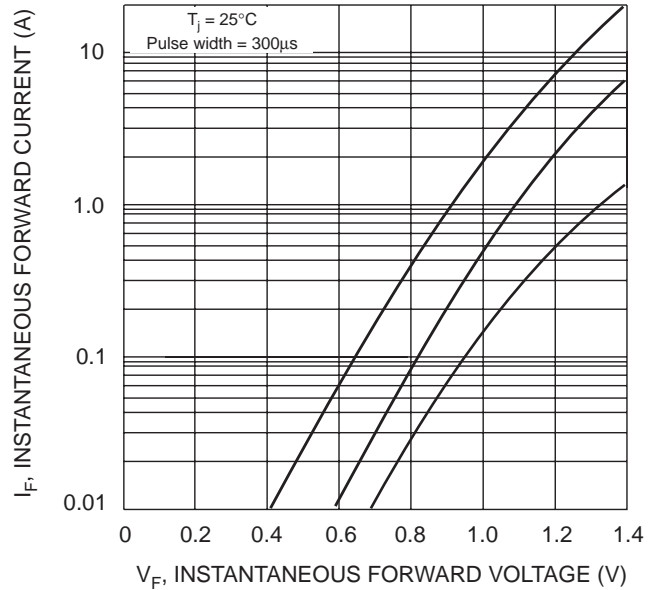

Fig. 2 Typical Forward Characteristics

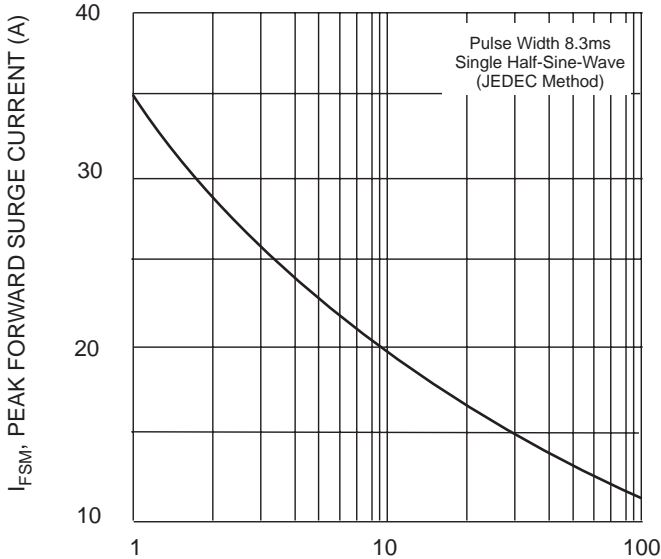

Fig. 3 Peak Forward Surge Current

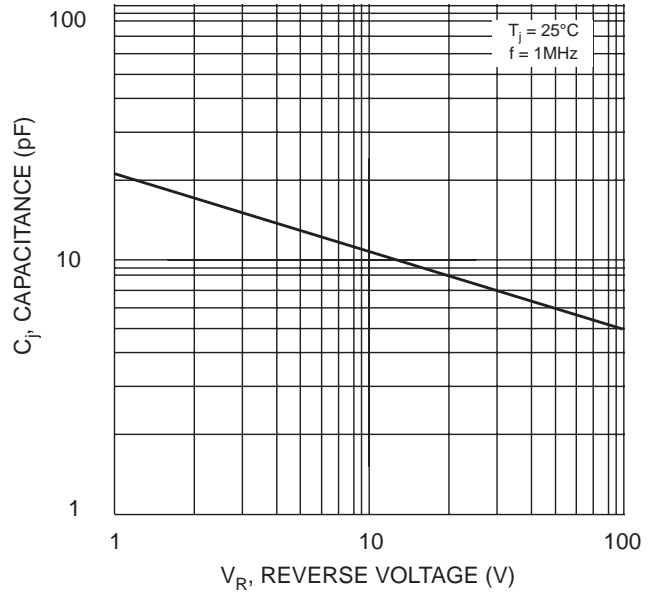
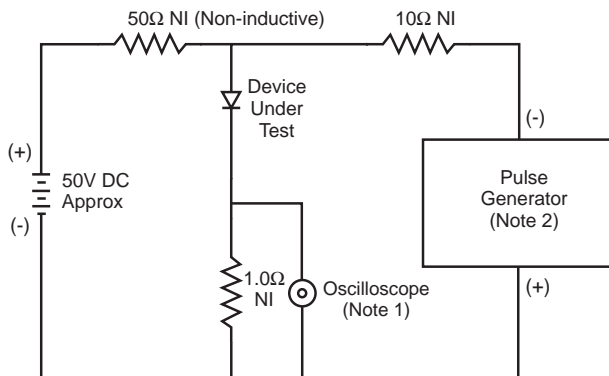
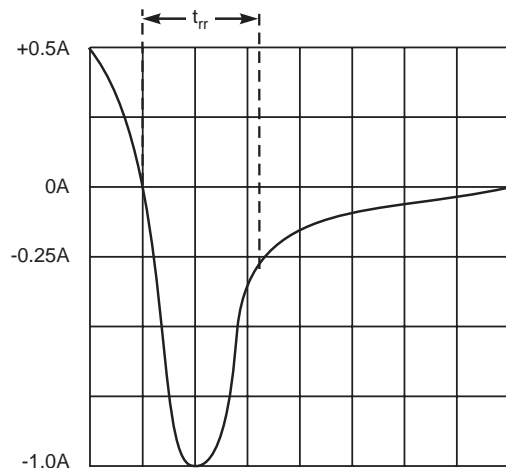

Fig. 4 Typical Junction Capacitance



- Notes:
1. Rise Time = 7.0ns max. Input Impedance = 1.0MΩ, 22pF.
  2. Rise Time = 10ns max. Input Impedance = 50Ω.



Set time base for 5/10ns/cm

### 5 Reverse Recovery Time Characteristic and Test Circuit