

Features

- Glass Passivated Die Construction
- Low Forward Voltage Drop
- High Current Capability
- High Surge Current Capability
- Designed for Surface Mount Application
- Plastic Material – UL Flammability 94V-0

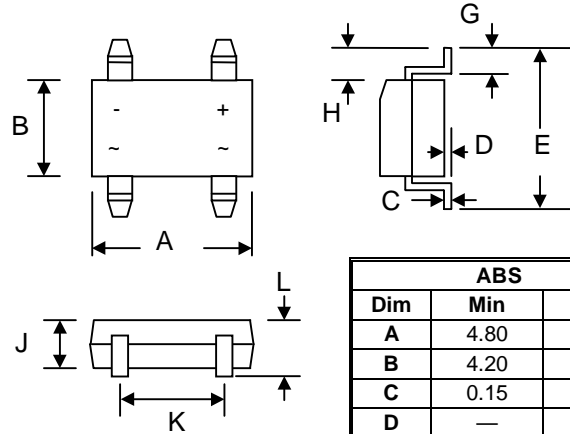

ABS		
Dim	Min	Max
A	4.80	5.30
B	4.20	4.60
C	0.15	0.25
D	—	0.20
E	6.00	6.80
G	0.30	0.70
H	0.90	1.10
J	—	1.50
K	3.80	4.20
L	1.22	1.72
All Dimensions in mm		

Mechanical Data

- Case: SOPA-4, ABS, Molded Plastic
- Terminals: Plated Leads Solderable per MIL-STD-202, Method 208
- Polarity: As Marked on Case
- Mounting Position: Any
- Marking: Type Number
- **Lead Free: For RoHS / Lead Free Version**

Maximum Ratings and Electrical Characteristics @ $T_A=25^\circ\text{C}$ unless otherwise specified

Single Phase, half wave, 60Hz, resistive or inductive load.
For capacitive load, derate current by 20%.

Characteristic	Symbol	EABS1	EABS2	EABS4	EABS6	Unit
Peak Repetitive Reverse Voltage	V_{RRM}					
Working Peak Reverse Voltage	V_{RWM}	100	200	400	600	V
DC Blocking Voltage	V_R					
RMS Reverse Voltage	$V_{R(RMS)}$	70	140	280	560	V
Average Rectified Output Current (Note 1) @ $T_A = 40^\circ\text{C}$	I_O	0.8				A
Average Rectified Output Current (Note 2) @ $T_A = 40^\circ\text{C}$						
Non-Repetitive Peak Forward Surge Current 8.3ms Single half sine-wave superimposed on rated load (JEDEC Method)	I_{FSM}	30				A
I^2t Rating for Fusing ($t < 8.3\text{ms}$)	I^2t	5.0				A^2s
Forward Voltage per element @ $I_F = 0.8\text{A}$	V_{FM}	0.95	1.25	1.7		V
Peak Reverse Current @ $T_A = 25^\circ\text{C}$	I_{RM}	5.0				μA
At Rated DC Blocking Voltage @ $T_A = 125^\circ\text{C}$		500				
Reverse Recovery Time (Note 4)	t_{rr}	35				nS
Typical Junction Capacitance per leg (Note 3)	C_j	13				pF
Typical Thermal Resistance per leg (Note 1)	$R_{\theta JA}$ $R_{\theta JL}$	62.5 25				$^\circ\text{C/W}$
Operating and Storage Temperature Range	T_j, T_{STG}	-55 to +150				$^\circ\text{C}$

Note: 1. Mounted on glass epoxy PC board with 1.3mm^2 solder pad.
2. Mounted on aluminum substrate PC board with 1.3mm^2 solder pad.
3. Measured at 1.0 MHz and applied reverse voltage of 4.0V D.C.
4. Measured with $I_F = 0.5\text{A}$, $I_R = 1.0\text{A}$, $I_{RR} = 0.25\text{A}$. See figure 5.

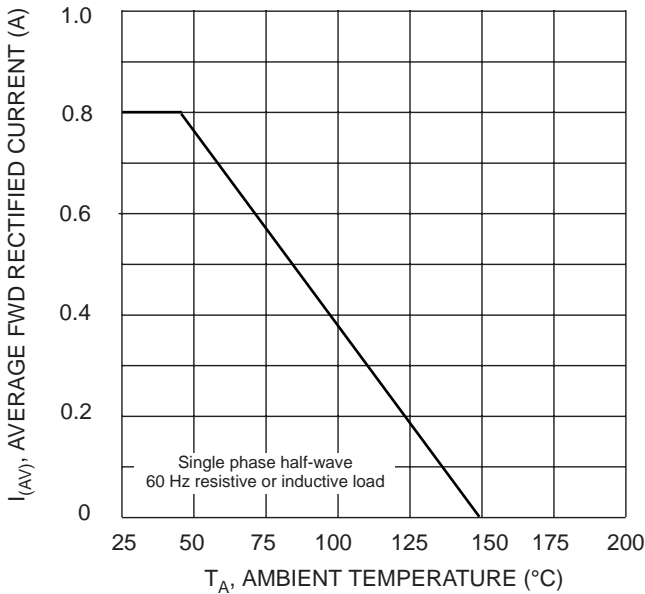

Fig. 1 Forward Derating Curve

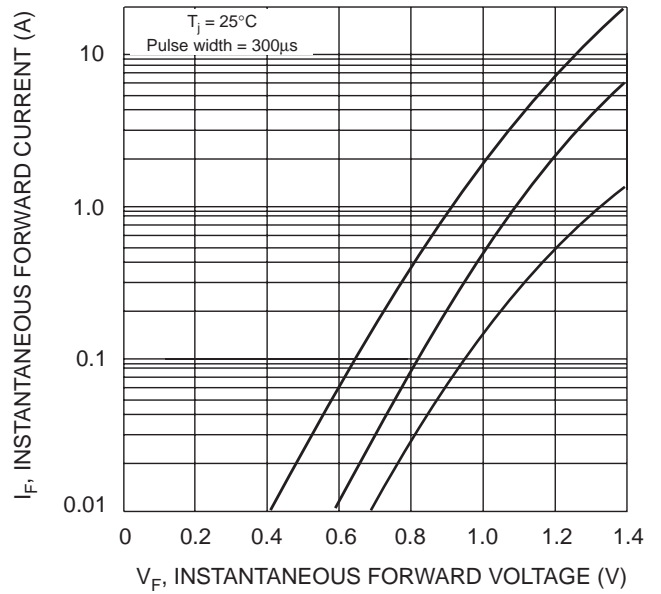

Fig. 2 Typical Forward Characteristics

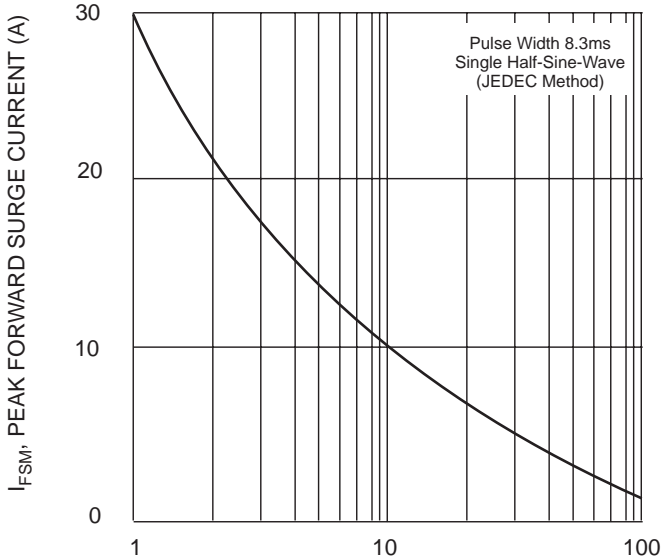

Fig. 3 Peak Forward Surge Current

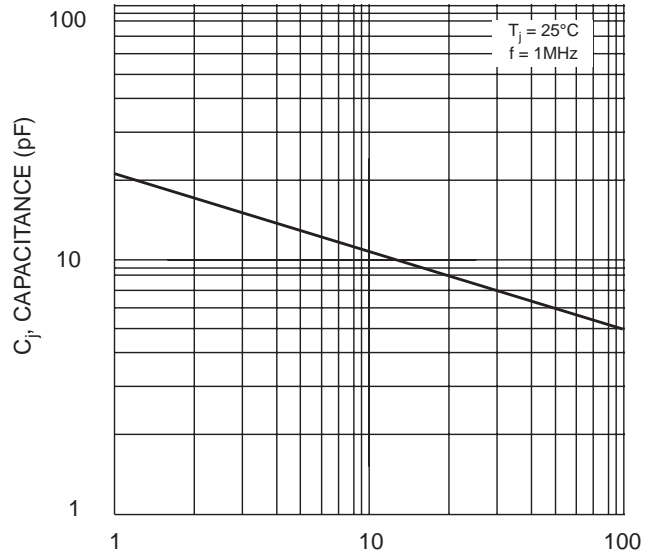
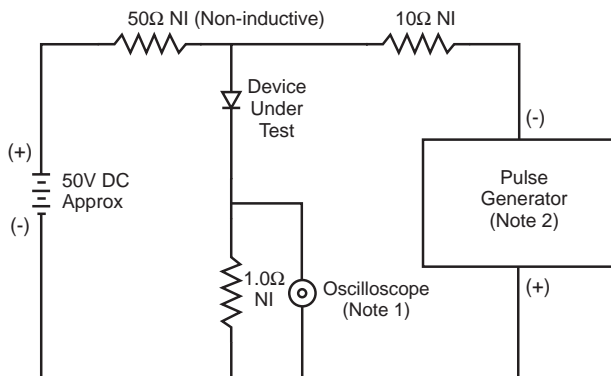
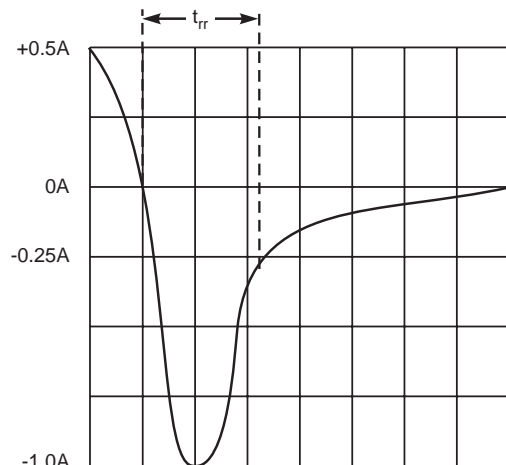

Fig. 4 Typical Junction Capacitance



- Notes:
1. Rise Time = 7.0ns max. Input Impedance = 1.0MΩ, 22pF.
 2. Rise Time = 10ns max. Input Impedance = 50Ω.



Set time base for 5/10ns/cm

5 Reverse Recovery Time Characteristic and Test Circuit