

#### Features

- Diffused Junction
- Low Forward Voltage Drop
- High Current Capability
- High Reliability
- High Surge Current Capability

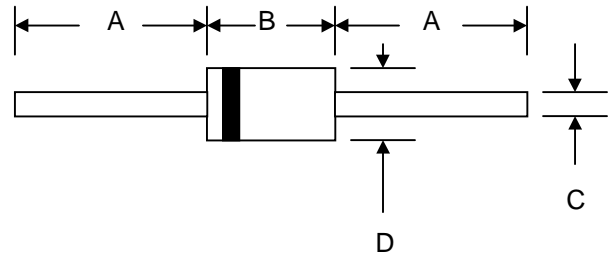

#### Mechanical Data

- Case: DO-41, Molded Plastic
- Terminals: Plated Leads Solderable per MIL-STD-202, Method 208
- Polarity: Cathode Band
- Weight: 0.34 grams (approx.)
- Mounting Position: Any
- Marking: Type Number
- **Lead Free: For RoHS / Lead Free Version**

DO-41		
Dim	Min	Max
A	24.5	—
B	4.06	5.21
C	0.60	0.80
D	2.00	3.00
All Dimensions in mm		

#### Maximum Ratings and Electrical Characteristics @ $T_A=25^\circ\text{C}$ unless otherwise specified

Single Phase, half wave, 60Hz, resistive or inductive load.  
For capacitive load, derate current by 20%.

Characteristic	Symbol	1N4933	1N4934	1N4935	1N4936	1N4937	Unit
Peak Repetitive Reverse Voltage	$V_{RRM}$						
Working Peak Reverse Voltage	$V_{RWM}$	50	100	200	400	600	V
DC Blocking Voltage	$V_R$						
RMS Reverse Voltage	$V_{R(RMS)}$	35	70	140	280	420	V
Average Rectified Output Current (Note 1)	$I_O$	1.0					A
		@ $T_A = 55^\circ\text{C}$					
Non-Repetitive Peak Forward Surge Current 8.3ms Single half sine-wave superimposed on rated load (JEDEC Method)	$I_{FSM}$	30					A
Forward Voltage	$V_{FM}$	1.28					V
		@ $I_F = 1.0\text{A}$					
Peak Reverse Current	$I_{RM}$	2.0					$\mu\text{A}$
		@ $T_A = 25^\circ\text{C}$					
At Rated DC Blocking Voltage		100					
		@ $T_A = 100^\circ\text{C}$					
Reverse Recovery Time (Note 2)	$t_{rr}$	200					nS
Typical Junction Capacitance (Note 3)	$C_j$	15					pF
Operating Temperature Range	$T_j$	-55 to +150					$^\circ\text{C}$
Storage Temperature Range	$T_{STG}$	-55 to +150					$^\circ\text{C}$

Note: 1. Leads maintained at ambient temperature at a distance of 9.5mm from the case  
2. Measured with  $I_F = 0.5\text{A}$ ,  $I_R = 1.0\text{A}$ ,  $IRR = 0.25\text{A}$ . See figure 5.  
3. Measured at 1.0 MHz and applied reverse voltage of 4.0V D.C.

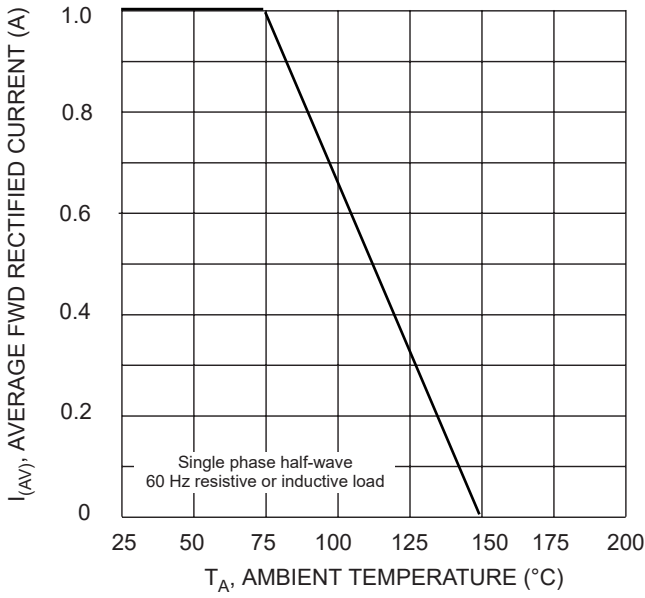

Fig. 1 Forward Derating Curve

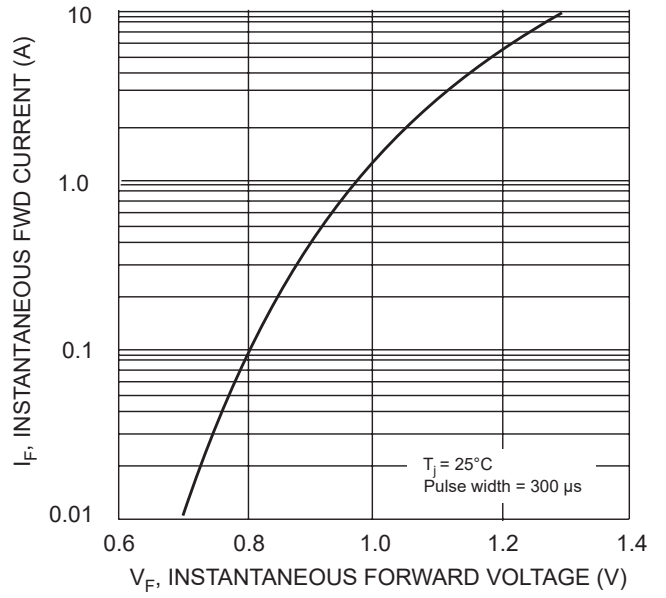

Fig. 2 Typical Forward Characteristics

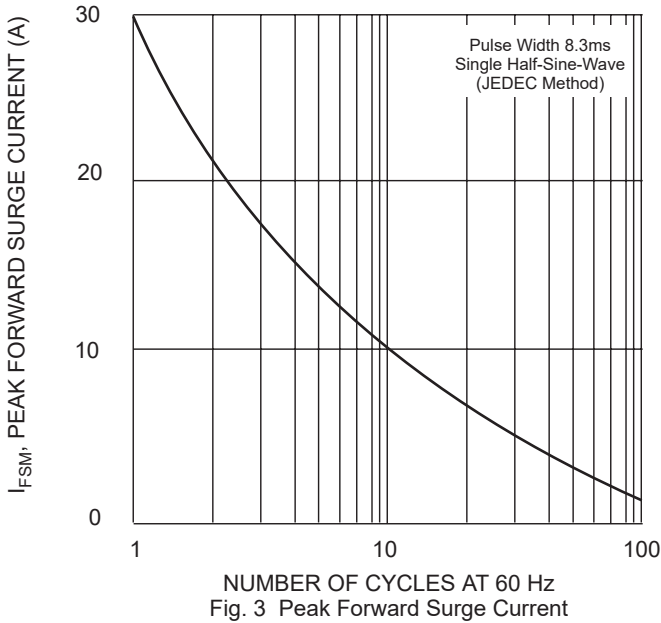

Fig. 3 Peak Forward Surge Current

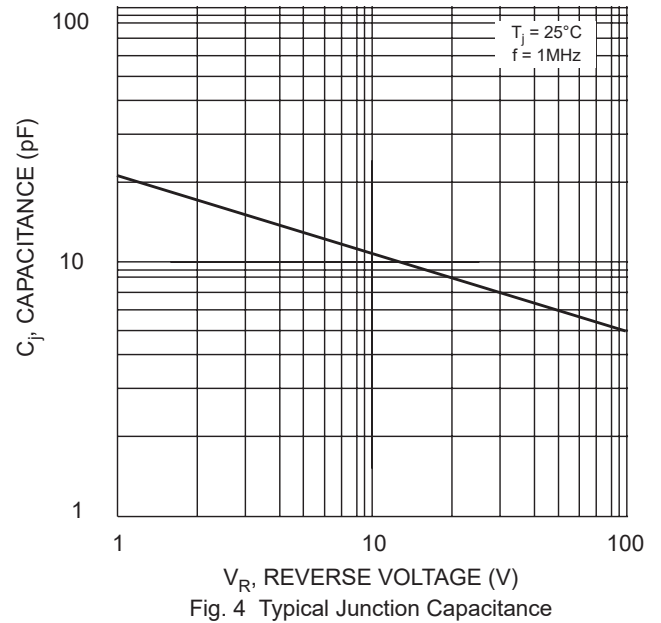
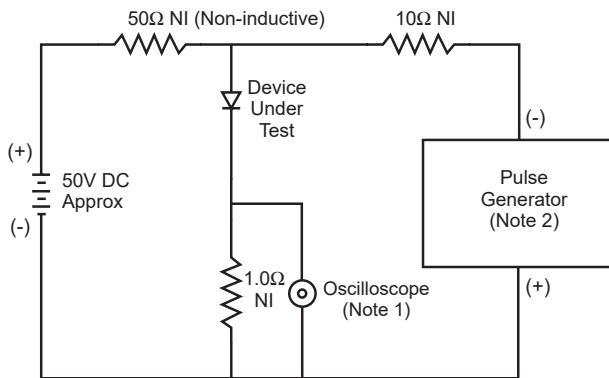
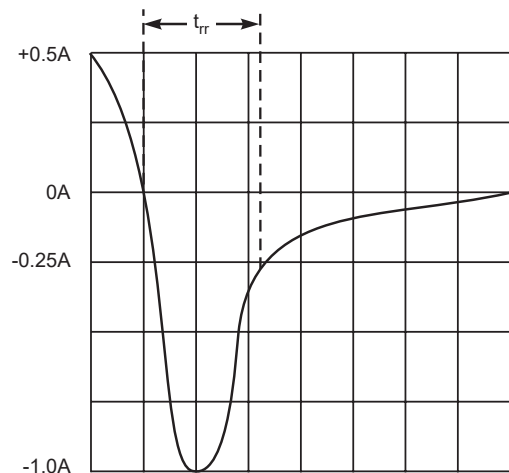

Fig. 4 Typical Junction Capacitance



- Notes:
1. Rise Time = 7.0ns max. Input Impedance = 1.0MΩ, 22pF.
  2. Rise Time = 10ns max. Input Impedance = 50Ω.



Set time base for 5/10ns/cm

Fig. 5 Reverse Recovery Time Characteristic and Test Circuit